



1- Purchasing information

P.O. number:* _____ Date: _____
 Company Name:* _____
 Purchasing contact:* _____
 Phone:* _____
 Email:* _____
 Contact preference:* Phone Email
 Marked for: _____

3- Shipping information

Ship to:* _____
 Name: _____
 Address: _____
 City: _____ Province: _____
 Postal Code: _____
 Phone: _____

2- Dealer/Representative information

Dealer/Representative:* _____
 Phone:* _____
 Email:* _____
 Contact preference:* Phone Email

MA080 English Manual (STD) MA081 Manuel Français

* Required

MODEL				Taxes not included					
WC20	<input type="checkbox"/>	Ultralight VELOCE Wheelchair (265 lb weight limit)		WMO001029 /	\$5,195				
WC09	<input type="checkbox"/>	HD Heavy Duty package (350 lb weight capacity)		WAM7	\$180				
WC10	<input type="checkbox"/>	E-Motion adaptor Kit (2 adaptors) - Only necessary with 6° camber		WAMF	\$35				
Frame									
SEAT WIDTH ³									
SW	<input type="checkbox"/>	14" <input type="checkbox"/>	15" <input type="checkbox"/>	16" <input type="checkbox"/>	17" <input type="checkbox"/>	18" ² <input type="checkbox"/>			NC
	<input type="checkbox"/>	19" ² <input type="checkbox"/>	20" ² <input type="checkbox"/>	21" ⁷ <input type="checkbox"/>	22" ⁷ <input type="checkbox"/>		WAMA		\$360
SEAT DEPTH									
SD	<input type="checkbox"/>	14" ¹ <input type="checkbox"/>	15" <input type="checkbox"/>	16" <input type="checkbox"/>	17" <input type="checkbox"/>	18" <input type="checkbox"/>			NC
	<input type="checkbox"/>	19" <input type="checkbox"/>	20" <input type="checkbox"/>				WAMB		\$275
FRAME LENGTH (Seat sling depth plus distance from seat sling to front of frame) ⁴									
SP01	<input type="checkbox"/>	Standard frame length configuration ⁵							STD
SP02	<input type="checkbox"/>	Frame length 1" longer than standard configuration							NC
SP03	<input type="checkbox"/>	Frame length 2" longer than standard configuration							NC
SP04	<input type="checkbox"/>	Frame length 1" shorter than standard configuration							NC
SP05	<input type="checkbox"/>	Frame length 2" shorter than standard configuration							NC
TRANSIT TIE DOWN									
AC05-S	<input type="checkbox"/>	WC-19 Transit Tie Down w/Q'straint belt ⁶		Short belt 20"-41"					\$365
AC05-L	<input type="checkbox"/>	WC-19 Transit Tie Down w/Q'straint belt ⁶		Long belt 20"-46"					\$365
AC35	<input type="checkbox"/>	WC-19 Transit Tie Down without belt ⁶							\$345

1- Only available with frame length 1" and 2" longer; 2- Available with HD option [3- Width calculator](#) 4- See chart at page 7; 5- 4.375" from seat sling to front frame
 6- May interfere with swing away armrest and Clamp on height adjustable push handle; Not available with HD option; 7- Only available with HD option and the one piece adjustable angle flip-up

FRONT Seat-to-floor height

Caster sizes	Height available +/- 1/4"	
<input type="checkbox"/> 3" Caster	14" to 21"	Specify desired height: _____ (inches)
<input type="checkbox"/> 4" Caster	14.5" to 21"	
<input type="checkbox"/> 5" Caster	15.5" to 21"	
<input type="checkbox"/> 6" Caster	16.5" to 21" (N/A with 90° front frame)	

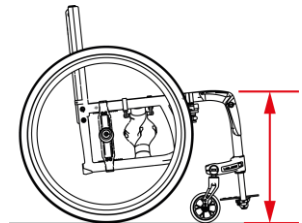

CASTERS				Availability		
CA01-03 to CA01-06	<input type="checkbox"/>	Composite wheel w/ PU tire (1")		3", 4", 5", 6"		NC
CA10	<input type="checkbox"/>	Pneumatic casters (1 ¼")		6"		\$170
CA14 to CA16	<input type="checkbox"/>	Newton UltraCaster Composite (1 ½ ")		4", 5", 6"		\$105
CA17 to CA19	<input type="checkbox"/>	Newton UltraCaster Aluminum (1 ½ ")		4", 5", 6"		\$198
CASTER OPTIONS						
CA13	<input type="checkbox"/>	Carbon fiber Frog Legs suspension forks (Not available with caster pin locks)				\$525

Veloce - REAR Seat-to-floor Height

WHEEL SIZES		Height available	Specify desired height: <hr/> (inches)
<input type="checkbox"/>	22" (501) wheel	13 1/2" to 18 1/4"	
<input type="checkbox"/>	24" (540) wheel	14 1/2" to 18 1/4"	
<input type="checkbox"/>	25" (559) wheel	15" to 19 3/4"	
<input type="checkbox"/>	26" (590) wheel	15 1/2" to 20 1/4"	

Configuration used: 1" seat slope with a center of gravity at 2"

Note: Tire size, center of gravity setting and seat slope may result in a variation of +/- ½" of selected seat to floor height"

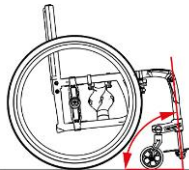
FRONT FRAME ANGLE						
FA70	<input type="checkbox"/>	70° Front frame angle				NC
FA75	<input type="checkbox"/>	75° Front frame angle				NC
FA80	<input type="checkbox"/>	80° Front frame angle				NC
FA85	<input type="checkbox"/>	85° Front frame angle				NC
FA90	<input type="checkbox"/>	90° Front frame angle				NC

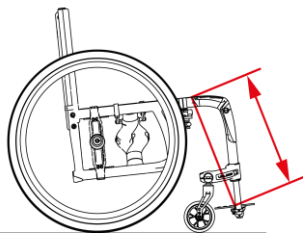
SEAT TO FOOTREST LENGTH						
Set Length to: ¹		Length must be at least 1 ¼" shorter than front seat-to-floor height				
1- +/- 1/2"						
						

Footrest width / Taper selection		
Seat Width	Straight ¹	1" Taper
Outside Measurement	2 ½" Narrower than Seat Width	4 ½" Narrower than Seat Width
14"	11.5"	9.5"
15"	12.5"	10.5"
16"	13.5"	11.5"
17"	14.5"	12.5"
18"	15.5"	13.5"
19"	16.5"	14.5"
20"	17.5"	15.5"
21"	18.5"	16.5"
22"	19.5"	17.5"

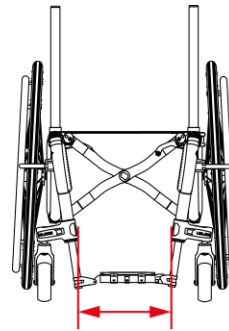

1- Not compatible with auto-folding footplate

FOOTPLATES						
FP02	<input type="checkbox"/>	Newton adjustable angle footplate - Composites (Two piece)				\$155
FP03	<input type="checkbox"/>	Newton adjustable angle - Aluminum (Two piece)				\$175
FP04	<input type="checkbox"/>	Newton adjustable angle footplate - Carbon fiber with rubber inserts (Two piece)				\$395
FP06	<input type="checkbox"/>	One piece adjustable angle flip-up - Aluminum		WAMI / SEFND0015	STD	
FP07	<input type="checkbox"/>	One piece adjustable angle flip-up - Carbon fiber with rubber inserts		WAMI / SEFND0015		\$480
FP28	<input type="checkbox"/>	One piece auto-folding adjustable angle - Aluminum				\$380
FP29	<input type="checkbox"/>	One piece auto-folding adjustable angle - Carbon fiber with rubber inserts				\$470
FOOTPLATE ACCESSORIES						
FP08	<input type="checkbox"/>	Length adjustable heel loop (not available with one piece footplate)				NC
FP09	<input type="checkbox"/>	Calf strap		SEFND0010		\$57
FP30	<input type="checkbox"/>	Bodypoint Aeromesh Padded calf strap				\$140

Backrest

FIXED HEIGHT WITHOUT PUSH HANDLE OPTIONS						
BC03-9		Ultraight carbon fiber back cane	9"		*Temporarily unavailable	NC
BC03-12		Ultraight carbon fiber back cane	12"		*Temporarily unavailable	NC
BC03-15		Ultraight carbon fiber back cane	15"		*Temporarily unavailable	NC
BC03-18		Ultraight carbon fiber back cane	18"		*Temporarily unavailable	NC
BC03-21		Ultraight carbon fiber back cane	21"		*Temporarily unavailable	NC
BC04-13		8° bend carbon fiber back cane	13 ½"		*Temporarily unavailable	\$175
BC04-15		8° bend carbon fiber back cane	15"		*Temporarily unavailable	\$175
BC04-18		8° bend carbon fiber back cane	18"		*Temporarily unavailable	\$175

*** Replacement options below: 1-Carbon fiber height adjustable; 2- Fixed height aluminum; 3- carbon fiber height and angle adjustable**

HEIGHT ADJUSTABLE WITH PUSH HANDLES OPTIONS (MUST select ONE push handle options)						
BC06-912	<input type="checkbox"/>	Straight Carbon fiber back cane	9" - 12"	increment of 1/2"	Set at ² :	NC
BC06-1215	<input type="checkbox"/>	Straight Carbon fiber back cane	12" - 15"	increment of 1/2"	Set at ² :	NC
BC06-1518	<input type="checkbox"/>	Straight Carbon fiber back cane	15" - 18"	increment of 1/2"	Set at ² :	NC
BC06-1821	<input type="checkbox"/>	Straight Carbon fiber back cane	18" - 21"	increment of 1/2"	Set at ² :	NC
BC08-1315	<input type="checkbox"/>	8° Bend Carbon fiber back cane	13.5" - 15"	increment of 1/2"	Set at ² :	\$175
BC08-1518	<input type="checkbox"/>	8° Bend Carbon fiber back cane	15" - 18"	increment of 1/2"	Set at ² :	\$175
BC08-1821	<input type="checkbox"/>	8° Bend Carbon fiber back cane	18" - 21"	increment of 1/2"	Set at ² :	\$175

FIXED HEIGHT WITHOUT PUSH HANDLE OPTIONS						
BC30	<input type="checkbox"/>	Straight aluminum back cane	9"			NC
BC36	<input type="checkbox"/>	Straight aluminum back cane	12"			NC
BC42	<input type="checkbox"/>	Straight aluminum back cane	15"			NC
BC63	<input type="checkbox"/>	8° bend aluminum back cane	13 ½"			\$175
BC64	<input type="checkbox"/>	8° bend aluminum back cane	15"			\$175

ANGLE AND HEIGHT ADJUSTABLE BACK CANE WITH PUSH HANDLE OPTIONS (MUST select ONE push handle options)						
BC09-1215	<input type="checkbox"/>	Straight Carbon fiber back cane	12" - 15"	increment of 1/2"	Set at ² :	\$330
BC09-1518	<input type="checkbox"/>	Straight Carbon fiber back cane	15" - 18"	increment of 1/2"	Set at ² :	\$330
BC09-1821	<input type="checkbox"/>	Straight Carbon fiber back cane	18" - 21"	increment of 1/2"	Set at ² :	\$330
BC10-1315	<input type="checkbox"/>	8° bend Carbon fiber back cane	13.5" - 15"	increment of 1/2"	Set at ² :	\$380
BC10-1518	<input type="checkbox"/>	8° bend Carbon fiber back cane	15" - 18"	increment of 1/2"	Set at ² :	\$380
BC10-1821	<input type="checkbox"/>	8° bend Carbon fiber back cane	18" - 21"	increment of 1/2"	Set at ² :	\$380
		Select back cane angle:	85° ¹ <input type="checkbox"/>	90° <input type="checkbox"/>	95° STD <input type="checkbox"/>	100° <input type="checkbox"/>
			105° <input type="checkbox"/>	110° <input type="checkbox"/>		

PUSH HANDLES OPTIONS (ONE option at a time)						
PH01	<input type="checkbox"/>	Push handles				STD
PH05	<input type="checkbox"/>	Fold down push handles ^{3,5}				\$165
PH06-920	<input type="checkbox"/>	Clamp on height adjustable push handles 9 - 20" ^{3, 4, 5}				\$345
PH06-923	<input type="checkbox"/>	Clamp on height adjustable push handles 9 - 23" ^{3, 4, 5}				\$345
PH02	<input type="checkbox"/>	Omit push handles				NC

1- Not available with a 8° bend back cane; 2- If not indicated, default height setting is at the lowest position; measured from seat sling to top of back upholstery; 3- 265lb weight limit
 4- Not compatible with swing away armrests and 8° bend back canes; 5- Not compatible with headrest and attendant lock

BACK UPHOLSTERY						
BH07	<input type="checkbox"/>	Slip-on Active-Mesh back upholstery				NC
BH08	<input type="checkbox"/>	Adjustable tension Active-Mesh back upholstery			WAMD/WAME	\$260
BH99	<input type="checkbox"/>	Omit Back upholstery				STD
	<input type="checkbox"/>	NXT back Support			See pricelist	

SEAT CUSHION						
SC01	<input type="checkbox"/>	2" Cushion				\$185
SC02	<input type="checkbox"/>	3" Cushion				\$205
SC99	<input type="checkbox"/>	Omit seat cushion				STD
	<input type="checkbox"/>	NXT cushion			See price list	

Rear wheels													
ONE ARM DRIVE ¹ <i>Only available with Newton One rear wheels with Aluminum, permanent axles, 0° camber</i>													
HR22	<input type="checkbox"/>	One arm drive - aluminum inner handrim ^{2,3}	24"	Left <input type="checkbox"/>	Right <input type="checkbox"/>			WAML	\$1,480				
HR60	<input type="checkbox"/>	One arm drive - plastic coated inner handrim ^{2,3}	24"	Left <input type="checkbox"/>	Right <input type="checkbox"/>			WAML	\$1,595				
HR98	<input type="checkbox"/>	Omit handrim on opposite side of the One Arm Drive (OAD)							NC				
REAR WHEELS													
Available													
RW01	<input type="checkbox"/>	Mag ⁴				22" 24"			\$140				
RW02	<input type="checkbox"/>	Newton One - spoke wheel ⁵				22" 24"			SF				
RW03	<input type="checkbox"/>	Newton Gravity - ultralight wheel				22", 24", 25", 26"			\$390				
RW04	<input type="checkbox"/>	Spinergy Spox	Blk STD <input type="checkbox"/>	Wht ⁶ <input type="checkbox"/>	Blue ⁶ <input type="checkbox"/>	Red ⁶ <input type="checkbox"/>	Yel ⁶ <input type="checkbox"/>	22", 24", 25", 26"	\$875				
RW05	<input type="checkbox"/>	Spinergy LX	Blk STD <input type="checkbox"/>	Pur ⁶ <input type="checkbox"/>	Wht ⁶ <input type="checkbox"/>	Blue ⁶ <input type="checkbox"/>	Red ⁶ <input type="checkbox"/>	Yel ⁶ <input type="checkbox"/>	Pink ⁶ <input type="checkbox"/>	Grn ⁶ <input type="checkbox"/>	Org ⁶ <input type="checkbox"/>	22", 24", 25", 26"	\$1,095
RW07	<input type="checkbox"/>	Spinergy CLX ⁷	Blk STD <input type="checkbox"/>	Pur ⁶ <input type="checkbox"/>	Wht ⁶ <input type="checkbox"/>	Blue ⁶ <input type="checkbox"/>	Red ⁶ <input type="checkbox"/>	Yel ⁶ <input type="checkbox"/>	Pink ⁶ <input type="checkbox"/>	Grn ⁶ <input type="checkbox"/>	Org ⁶ <input type="checkbox"/>	24", 25"	\$1,650
TIRES													
Available													
Solid													
TI01	<input type="checkbox"/>	Soft Urethane 1 3/8"				22" 24"			NC				
TI02	<input type="checkbox"/>	Soft Urethane knobby 1 3/8" ⁸				22", 24", 25", 26"			\$120				
TI04	<input type="checkbox"/>	Soft Urethane 1" - <i>Shox</i>				22", 24", 25", 26"			\$140				
Pneumatic													
TI05	<input type="checkbox"/>	Pneumatic 1 3/8"				22", 24", 25", 26"			NC				
TI08	<input type="checkbox"/>	Pneumatic with Airless insert 1 3/8" ⁹				22", 24", 26"			\$225				
TI06	<input type="checkbox"/>	Pneumatic HP, Low Tread, Puncture resistant, black 1" - <i>SpeedLite</i>				22", 24", 25", 26"			\$120				
TI07	<input type="checkbox"/>	Pneumatic HP, Medium Tread, Puncture resistant, black 1" - <i>TrailBlazer</i>				24", 25", 26"			\$200				

- 1- Offered with handrims on each side of the wheelchair; select the outer handrim in the handrims section; 2- Only standard handrim position available; 3- Not available with HD option
4- Not compatible with HP tires; Only available with aluminum or plastic coated handrim, standard position; 5- Not compatible with Shox tires; 6- color spokes require an additional 10 days lead-time;
7- Only available with 1" tires; 8- 22" is only available with Mags and Newton One rear wheels; 9- Not available with Spinergy CLX, Spinergy LX 25", 26" and Spox 25", 26" rear wheels

Handrims										
HANDRIM										
Available										
HR01	<input type="checkbox"/>	Aluminum anodized				22", 24", 25", 26"			STD	
HR61	<input type="checkbox"/>	Aluminum black hard anodized ²				22", 24", 25"			\$85	
HR02	<input type="checkbox"/>	Plastic coated ¹				22", 24", 25", 26"		WAMO	\$170	
HR03	<input type="checkbox"/>	High friction coated ^{1,2,3}				22", 24", 25", 26"		WAMO	\$460	
HR07-HR18 and HR65-HR71	<input type="checkbox"/>	Newton Air Grip ²	<i>See page 6 for the color selection and price</i>				22", 24", 25", 26"		WAMO	
HR28	<input type="checkbox"/>	Surge ^{1,2,3} (1 1/2" Oval handrim w/ Gripton high friction strip)				22", 24", 25", 26"			\$485	
HR05	<input type="checkbox"/>	Surge LT ^{1,2,3} (1 1/8" Oval handrim w/ Gripton high friction strip)				22", 24", 25", 26"			\$515	
HR04	<input type="checkbox"/>	Natural Fit ^{1,2,3}				22", 24", 25", 26"			\$320	
HR62	<input type="checkbox"/>	Simi H ^{1,2,3} (1 1/4" Oval handrim with high friction strip)				22", 24", 25", 26"			\$485	
HR63	<input type="checkbox"/>	Nova H ^{1,2,3} (1 1/4" Oval handrim with high friction strip)				22", 24", 25", 26"			\$515	
HR64	<input type="checkbox"/>	Optimum H ^{1,2,3} (1 1/8" heart-shaped handrim)				22", 24", 25", 26"			\$320	
HR99	<input type="checkbox"/>	Omit handrim							NC	

- 1- Only standard and narrow handrim position. By default, the tab won't be cut with the narrow position; 2- Not available with Mag wheels; 3 - Not available with one arm drive;

Handrims option									
ASSEMBLY POSITION									
HR29	<input type="checkbox"/>	Standard Handrim position	Full tab						STD
HR030	<input type="checkbox"/>	Narrow Handrim position no cut	Full tab						NC
HR30	<input type="checkbox"/>	Narrow Handrim position with cut ³	Short tab 2 positions						\$29
HR31	<input type="checkbox"/>	Super Narrow Handrim ³	Short tab 2 positions STD <input type="checkbox"/>	Short tab 1 position <input type="checkbox"/>					\$29
THUMB PIECE SELECTION FOR NATURAL FIT, SURGE, SURGE LT HANDRIMS									
HR23	<input type="checkbox"/>	Standard grip							\$200
HR27	<input type="checkbox"/>	Super grip							\$230
HR099	<input type="checkbox"/>	Omit thumb piece							NC

- 3- Only available with Aluminum and Air Grip handrims;

AXLE ¹						
AX01	<input type="checkbox"/>	Quick release axle			WAMU	STD
AX03	<input type="checkbox"/>	Quad release axle			WAMU	\$180

1- Not required with one arm drive

REAR WHEEL CAMBER						
CM00	<input type="checkbox"/>	0° camber				STD
CM03	<input type="checkbox"/>	3° camber				NC
CM06	<input type="checkbox"/>	6° camber				\$85

CENTER OF GRAVITY

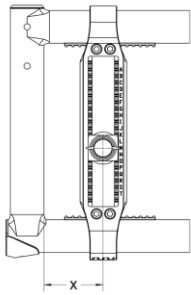

Choose position of rear wheel axle plate:

Measure distance X from front of back post to center of axle receiver.

Most stable													
X =	1"	1/4"	1/2"	3/4"	2"	1/4"	1/2"	3/4"	3"	1/4"	1/2"	3/4"	4"
	<input type="checkbox"/>	<input type="checkbox"/>	<input type="checkbox"/>	<input type="checkbox"/>	<input type="checkbox"/>	<input type="checkbox"/>	<input type="checkbox"/>	<input type="checkbox"/>	<input type="checkbox"/>	<input type="checkbox"/>	<input type="checkbox"/>	<input type="checkbox"/>	<input type="checkbox"/>

If not indicated, default setting is at 1.5"

Possible conflict between a seat depth under 16" and a center of gravity over 2.5".

Possible conflict between a 26" rear wheel and a center of gravity over 2.5".

Motion Composites will select the closest possible center of gravity (COG) if an issue arises with the COG

WHEEL LOCK						
WL08	<input type="checkbox"/>	Newton Wheel lock - push to lock				STD
WL14	<input type="checkbox"/>	6" removable extension handle for push to lock				\$73
WL16	<input type="checkbox"/>	Aluminum push to lock with extensions				\$73
WL02	<input type="checkbox"/>	Pull to lock				NC
WL04	<input type="checkbox"/>	Newton grade aid push to lock (works best with pneumatic or high pressure tire)			WAMR	\$185
WL13	<input type="checkbox"/>	6" removable extension handle for pull to lock and grade aid				\$73
WL05	<input type="checkbox"/>	Scissors Lock				\$185
WL15	<input type="checkbox"/>	Unilateral wheel lock - pull to lock ¹	Left <input type="checkbox"/>	Right <input type="checkbox"/>	WAMN	\$335
WL99	<input type="checkbox"/>	Omit wheel locks				NC

1- For more information about incompatibilities and restriction, refer to the table at page 7 and the "How-to documents" page of our website:

https://www.motioncomposites.com/en_ca/support-and-education/how-to-documents

Armrests						
HEIGHT ADJUSTABLE FLIP BACK ARMREST (Convertible to "T" armrest) ¹						
AR01-812	<input type="checkbox"/>	10" Desk length armpad	8" - 12"	Locked <input type="checkbox"/>	Unlocked STD <input type="checkbox"/>	\$395
AR01-1014	<input type="checkbox"/>	10" Desk length armpad	10" - 14"	Locked <input type="checkbox"/>	Unlocked STD <input type="checkbox"/>	\$395
AR02-812	<input type="checkbox"/>	14" Full length armpad	8" - 12"	Locked <input type="checkbox"/>	Unlocked STD <input type="checkbox"/>	\$395
AR02-1014	<input type="checkbox"/>	14" Full length armpad	10" - 14"	Locked <input type="checkbox"/>	Unlocked STD <input type="checkbox"/>	\$395
HEIGHT ADJUSTABLE "T" ARMREST ¹						
AR13-610	<input type="checkbox"/>	10" Desk length armpad ⁴	6" - 10"			\$380
AR03-812	<input type="checkbox"/>	10" Desk length armpad	8" - 12"			\$380
AR03-1014	<input type="checkbox"/>	10" Desk length armpad	10" - 14"			\$380
AR14-610	<input type="checkbox"/>	14" Full length armpad ⁴	6" - 10"			\$380
AR04-812	<input type="checkbox"/>	14" Full length armpad	8" - 12"			\$380
AR04-1014	<input type="checkbox"/>	14" Full length armpad	10" - 14"			\$380
HEIGHT ADJUSTABLE SWING AWAY ARMREST ²						
AR05	<input type="checkbox"/>	Tubular armrest - Short pad	8" - 11"			\$315
AR23	<input type="checkbox"/>	Tubular armrest - Long pad	8" - 11"			\$315
AR06	<input type="checkbox"/>	10" Desk length flat armpad	8" - 11"			\$315
AR17	<input type="checkbox"/>	14" Full length flat armpad	8" - 11"			\$315
ARMRESTS OPTIONS						
AR12	<input type="checkbox"/>	14" Full Length armpad ³ - Gel Ovation			SEAND0030	\$160
AR99	<input type="checkbox"/>	Omit armrest				NC

1- May have a 1/2" adjustment restriction on both limits of the range; 2- Could interfere with some rigid backrests; Not available with fixed carbon fiber side guards

3- Only available with full length armrest; Not available with tubular (short and long) and short armrest; 4- May have some restriction with seat-to-floor height and rear wheel

SIDE GUARDS (not available with Flip Back and "T" Armrest)						
SG01	<input type="checkbox"/>	Plastic side guards (removable)			WAMV	\$235
SG02	<input type="checkbox"/>	Carbon fiber side guards (fixed)			WAMV	\$285
SG03	<input type="checkbox"/>	Carbon fiber side guards (removable)			WAMV	\$320
SG06	<input type="checkbox"/>	Plastic fender side guards - straight bracket (removable)			WAMV	\$340
SG08	<input type="checkbox"/>	Plastic fender side guards - offset bracket (removable) ¹			WAMV	\$340
SG04	<input type="checkbox"/>	Carbon fiber fender side guards (removable)			WAMV	\$510
SG99	<input type="checkbox"/>	Omit side guard				NC
SIDE GUARDS OPTION						
SG07	<input type="checkbox"/>	Side guards clip (pair) ²				NC

1- only compatible with 0° camber; Increase distance between fender side guards by 1 1/8"; 2- Not available with fixed carbon fiber side guard

POSITIONING BELT						
SB01-S	<input type="checkbox"/>	Velcro adjustable - Standard 35" ¹				\$50
SB01-L	<input type="checkbox"/>	Velcro adjustable - Long 60"				\$50
SB02-S	<input type="checkbox"/>	Auto buckle - Standard 35" ¹				\$60
SB02-L	<input type="checkbox"/>	Auto buckle - Long 60"				\$60
SB04-M	<input type="checkbox"/>	BodyPoint Hip Belt - 2 point not padded - Medium 56"				\$95
SB04-L	<input type="checkbox"/>	BodyPoint Hip Belt - 2 point not padded - Long 61"				\$95
SB05-S	<input type="checkbox"/>	BodyPoint Hip Belt - 2 point padded - Small 51"		SERND0030		\$185
SB05-M	<input type="checkbox"/>	BodyPoint Hip Belt - 2 point padded - Medium 56"		SERND0030		\$185
SB05-L	<input type="checkbox"/>	BodyPoint Hip Belt - 2 point padded - Long 61"		SERND0030		\$185
SB06-S	<input type="checkbox"/>	BodyPoint Hip Belt - 4 point padded - Small 51"		SERND0020		\$210
SB06-M	<input type="checkbox"/>	BodyPoint Hip Belt - 4 point padded - Medium 56"		SERND0020		\$210
SB06-L	<input type="checkbox"/>	BodyPoint Hip Belt - 4 point padded - Long 61"		SERND0020		\$210
SB03	<input type="checkbox"/>	Hardware attachment for 2 extra points (1 pair)				\$15
SB08-M	<input type="checkbox"/>	BodyPoint EVOFLEX® Positioning Belt Rehab latch and Band Clamps - Medium 18"				\$355
SB08-L	<input type="checkbox"/>	BodyPoint EVOFLEX® Positioning Belt Rehab latch and Band Clamps - Long 24"				\$355
SB99	<input type="checkbox"/>	Omit positioning belt				STD

1- Not available with wheelchair width of 18" and more

HEADREST ¹						
AC01-S	<input type="checkbox"/>	Profiled Headrest - Small (3.5"X6")				\$215
AC01-M	<input type="checkbox"/>	Profiled Headrest - Medium (4.5"X7")				\$215
AC01-L	<input type="checkbox"/>	Profiled Headrest - Large (5.5"X8")				\$215
AC28	<input type="checkbox"/>	Headrest mounting hardware with stabilizer bar ¹				\$360

1- Only available with push handles

ACCESSORIES						
AC03	<input type="checkbox"/>	Anti-tippers				\$120
AC29	<input type="checkbox"/>	Swing-away anti-tipper ¹	Left <input type="checkbox"/>	Right <input type="checkbox"/>		\$185
AC27	<input type="checkbox"/>	Tip assist ²				\$65
AC06	<input type="checkbox"/>	Cane and crutch holder	Left <input type="checkbox"/>	Right <input type="checkbox"/>		\$115
AC08	<input type="checkbox"/>	Spoke guards ³	Available: 22", 24", 26"		WAMP	\$155
AC10	<input type="checkbox"/>	Seat pouch				\$100
AC26	<input type="checkbox"/>	BodyPoint Mobility Bag				\$145
AC23	<input type="checkbox"/>	Newton Backpack				\$130
AC30	<input type="checkbox"/>	Newton multi-purpose pouch				\$75
AC12	<input type="checkbox"/>	Velcro Closing Strap				\$55
AC13	<input type="checkbox"/>	Tool kit				\$55
AC16	<input type="checkbox"/>	Motion Composites Polo Shirt	W/S <input type="checkbox"/>	W/M <input type="checkbox"/>	W/L <input type="checkbox"/>	\$36
			M/S <input type="checkbox"/>	M/M <input type="checkbox"/>	M/L <input type="checkbox"/>	
				M/XL <input type="checkbox"/>	M/XXL <input type="checkbox"/>	
					M/XXXL <input type="checkbox"/>	

1- Must select the pair (left and right) with HD option; Only available with rear seat to floor height between 13 1/2" and 19 3/4"; 2- Cannot be combined with Anti Tippers

3- Not available with Mag wheels and Spinergy

Colors																					
Options ¹	Black	High Gloss Carbon Fiber	Sunkissed Orange	Burgundy	Sapphire Blue	Monster Green	Charcoal	Fuchsia	Steel Blue	Ferrari Red	Acid Green	Electric Purple	Caribbean Blue	White	Pink Pearl	Plum Purple	Sky Blue	Black Cherry	Khaki Green (matte)	Desert Sand (matte)	
AirGrip	<input type="checkbox"/>	<input type="checkbox"/>	<input type="checkbox"/>	<input type="checkbox"/>	<input type="checkbox"/>	<input type="checkbox"/>	<input type="checkbox"/>	<input type="checkbox"/>	<input type="checkbox"/>	<input type="checkbox"/>	<input type="checkbox"/>	<input type="checkbox"/>	<input type="checkbox"/>	<input type="checkbox"/>	<input type="checkbox"/>	<input type="checkbox"/>	<input type="checkbox"/>	<input type="checkbox"/>	<input type="checkbox"/>	<input type="checkbox"/>	\$350
Frame	<input type="checkbox"/>	<input type="checkbox"/>	<input type="checkbox"/>	<input type="checkbox"/>	<input type="checkbox"/>	<input type="checkbox"/>	<input type="checkbox"/>	<input type="checkbox"/>	<input type="checkbox"/>	<input type="checkbox"/>	<input type="checkbox"/>	<input type="checkbox"/>	<input type="checkbox"/>	<input type="checkbox"/>	<input type="checkbox"/>	<input type="checkbox"/>	<input type="checkbox"/>	<input type="checkbox"/>	<input type="checkbox"/>	<input type="checkbox"/>	NC
Highlight ²	<input type="checkbox"/>	<input type="checkbox"/>	<input type="checkbox"/>	<input type="checkbox"/>	<input type="checkbox"/>	<input type="checkbox"/>	<input type="checkbox"/>	<input type="checkbox"/>	<input type="checkbox"/>	<input type="checkbox"/>	<input type="checkbox"/>	<input type="checkbox"/>	<input type="checkbox"/>	<input type="checkbox"/>	<input type="checkbox"/>	<input type="checkbox"/>	<input type="checkbox"/>	<input type="checkbox"/>	<input type="checkbox"/>	<input type="checkbox"/>	NC
FC99	<input type="checkbox"/>	Custom Color	Specify PPG Paintit color:																	additional 10 days lead-time	\$422

1- Color representation may vary from one monitor to another. Therefore, the actual paint color on your wheelchair might differ slightly from what you see on your screen.; Finish between Airgrip and frame might be different;

2- To see different highlight, visit our website: https://www.motioncomposites.com/en_ca/products/folding-wheelchairs/veloce

Frame length chart

Frame length	Seat Depth						
	14"	15"	16"	17"	18"	19"	20"
STD	N/A	15"	16"	17"	18"	19"	20"
1	15"	16"	17"	18"	19"	20"	N/A
2	16"	17"	18"	19"	20"	N/A	N/A
-1	N/A	N/A	15"	16"	17"	18"	19"
-2	N/A	N/A	N/A	15"	16"	17"	18"

Unilateral wheel lock restrictions

Seat depth: shall be 16 in and greater		
Rear wheel: shall be 24 in and less		
"T" or flip-back armrest only compatible with 0° Camber		
One arm drive: Not compatible with "T" or flip-back armrest		
"T" or flip-back armrest may require to move the rear wheels outwards		
Not compatible with wheel lock lever extension		
Rear wheel diameter	Seat depth (in)	COG Compatibility Range (in)
20 in	16+	1.75 to 4
22 in	16+	2.5 to 4
24 in	16+	1 to 4

Notes :

 NXCAF _F _ _ _ _ (W" x D")	WIDTH										
	DEPTH	12"	12"	13"	14"	15"	16"	17"	18"	19"	20"
		12"	\$625	\$625	\$625						
		14"	\$625	\$625	\$625						
		15"		\$625	\$625	\$625					
		16"		\$625	\$625	\$625	\$625	\$625	\$625	\$655	\$655
		17"				\$625	\$625	\$625	\$625	\$655	\$655
		18"				\$625	\$625	\$625	\$625	\$655	\$655
		19"				\$625	\$625	\$625	\$625	\$655	\$655
		20"				\$625	\$625	\$625	\$655	\$655	\$655
Option: Change cover for incontinent / infection control outer cover										\$N/C	

SEATING AND CUSHION ACCESSORIES

	Model #	Description	Fits Back Width	\$	QTY
	RSSI 1600	Solid Seat Insert	Fits cushions 16" & 17" wide (40.6 & 43.2 cm) and 14"-18" deep (35.6-45.7 cm)	80	
	RSSI 1600	Solid Seat Insert	Fits cushions 18" & 19" wide (45.7 & 48.3 cm) and 14"-18" deep (35.6-45.7 cm)	80	
	RSSI 1600	Solid Seat Insert	Fits cushions 20"-22" wide (50.8-55.9 cm) and 18"-20" deep (45.7-50.8 cm)	80	

THORACIC SHAPE



Optima™ THORACIC BACK SUPPORT
CARBON FIBER SHELL (WEIGHT SAVINGS - 1lb)

Fits Width	Height	Model # CARBON FIBER	\$ CARBON	Model # Aluminum	\$ Aluminum
13"-15"	7"			NOACB1307	\$725
13"-15"	9"			NOACB1309	\$725
13"-15"	13"			NOACB1313	\$725
13"-15"	16"			NOACB1316	\$725
14"-16"	7"			NOACB1407	\$725
14"-16"	9"	NOCFACB1409	\$1150	NOACB1409	\$725
14"-16"	13"	NOCFACB1413	\$1150	NOACB1413	\$725
14"-16"	16"	NOCFACB1416	\$1150	NOACB1416	\$725
15"-17"	7"			NOACB1507	\$725
15"-17"	9"	NOCFACB1509	\$1150	NOACB1509	\$725
15"-17"	13"	NOCFACB1513	\$1150	NOACB1513	\$725
15"-17"	16"	NOCFACB1516	\$1150	NOACB1516	\$725
16"-18"	7"			NOACB1607	\$725
16"-18"	9"	NOCFACB1609	\$1150	NOACB1609	\$725
16"-18"	13"	NOCFACB1613	\$1150	NOACB1613	\$725
16"-18"	16"	NOCFACB1616	\$1150	NOACB1616	\$725
17"-19"	7"			NOACB1707	\$725
17"-19"	9"	NOCFACB1709	\$1150	NOACB1709	\$725
17"-19"	13"	NOCFACB1713	\$1150	NOACB1713	\$725
17"-19"	16"	NOCFACB1716	\$1150	NOACB1716	\$725
18"-20"	7"			NOACB1807	\$725
18"-20"	9"	NOCFACB1809	\$1150	NOACB1809	\$725
18"-20"	13"	NOCFACB1813	\$1150	NOACB1813	\$725
18"-20"	16"	NOCFACB1816	\$1150	NOACB1816	\$725
20"-22"	7"			NOACB2007	\$725
20"-22"	9"	NOCFACB2009	\$1150	NOACB2009	\$725
20"-22"	13"	NOCFACB2013	\$1150	NOACB2013	\$725
20"-22"	16"	NOCFACB2016	\$1150	NOACB2016	\$725



Optima™ DEEP THORACIC BACK SUPPORT
CARBON FIBER SHELL (WEIGHT SAVINGS - 1lb)

Fits Width	Height	Model # CARBON FIBER	\$ CARBON	Model # Aluminum	\$ Aluminum
13"-15"	7"			NOPCB1307	\$825
13"-15"	9"			NOPCB1309	\$825
13"-15"	13"			NOPCB1313	\$825
13"-15"	16"			NOPCB1316	\$825
14"-16"	7"			NOPCB1407	\$825
14"-16"	9"	NOCFPCB1409	\$1250	NOPCB1409	\$825
14"-16"	13"	NOCFPCB1413	\$1250	NOPCB1413	\$825
14"-16"	16"	NOCFPCB1416	\$1250	NOPCB1416	\$825
15"-17"	7"			NOPCB1507	\$825
15"-17"	9"	NOCFPCB1509	\$1250	NOPCB1509	\$825
15"-17"	13"	NOCFPCB1513	\$1250	NOPCB1513	\$825
15"-17"	16"	NOCFPCB1516	\$1250	NOPCB1516	\$825
16"-18"	7"			NOPCB1607	\$825
16"-18"	9"	NOCFPCB1609	\$1250	NOPCB1609	\$825
16"-18"	13"	NOCFPCB1613	\$1250	NOPCB1613	\$825
16"-18"	16"	NOCFPCB1616	\$1250	NOPCB1616	\$825
17"-19"	7"			NOPCB1707	\$825
17"-19"	9"	NOCFPCB1709	\$1250	NOPCB1709	\$825
17"-19"	13"	NOCFPCB1713	\$1250	NOPCB1713	\$825
17"-19"	16"	NOCFPCB1716	\$1250	NOPCB1716	\$825
18"-20"	7"			NOPCB1807	\$825
18"-20"	9"	NOCFPCB1809	\$1250	NOPCB1809	\$825
18"-20"	13"	NOCFPCB1813	\$1250	NOPCB1813	\$825
18"-20"	16"	NOCFPCB1816	\$1250	NOPCB1816	\$825
20"-22"	7"			NOPCB2007	\$825
20"-22"	9"	NOCFPCB2009	\$1250	NOPCB2009	\$825
20"-22"	13"	NOCFPCB2013	\$1250	NOPCB2013	\$825
20"-22"	16"	NOCFPCB2016	\$1250	NOPCB2016	\$825

ITEM	WIDTH X DEPTH	\$	QTY	ITEM	WIDTH X DEPTH	\$	QTY
Replacement Cover & Foam	NOACB _ _ _ _	130		Replacement Cover & Foam	NOPCB _ _ _ _	130	

PLEASE NOTE: Each back will fit widths up to 2" wider.

BACK SUPPORT HARDWARE OPTIONS

All backs come STANDARD with QuickRelease Mounting Hardware. The following are fixed hardware options available at no charge when ordered with a back support.

Model #	Description	Weight of Hardware Only	✓
	QuickFit Quick Release Hardware System	STANDARD (2 LBS)	STANDARD
NIB-1642	Micro Mount 2 point fixed hardware. Back width needs to match chair width	Weight savings of 1.4 lb over STANDARD	
NIB-1207	2 point fixed hardware. Width expandable to fit 3 sizes of chair	Weight savings of 1.0 lb over STANDARD	

BACK SUPPORT ACCESSORIES

	Model #	Description	Fits Back Width	\$	QTY
	Custom - Cover	Optional Infection Control Wipe Down Back Support Cover	Specify back model # when ordering		205
NIB-1938	Extra Small Privacy Flap for 11" - 13" wide back supports	11" - 13" (27.9 - 33.0)		70	
NIB-1078	Small Privacy Flap for 14"-16" wide back supports	14" - 16" (35.6-40.6 cm)		70	
NIB-1079	Medium Flap for 17"-19" wide back supports	17" - 19" (43.2-48.3 cm)		70	
NIB-1080	Large Privacy Flap for 20"-22" wide back supports	20" - 22" (50.8-55.9 cm)		70	
NIB-1081	Extra Large Privacy Flap for 23" - 26" wide back supports	23" - 26" (58.4 - 66.0 cm)		70	

ALL PRICES QUOTED IN CDN. PRICES ARE SUBJECT TO CHANGE WITHOUT NOTICE.

For additional NXT models, sizes and hardware not shown, please refer to the complete NXT Seating Order Form at www.motioncomposites.com