



1- Purchasing information

P.O. number:* _____ Date: _____
 Company Name:* _____
 Purchasing contact:* _____
 Phone:* _____
 Email:* _____
 Contact preference:* Phone Email
 Marked for: _____

2- ATP/Clinician information

ATP/Clinician:* _____
 Phone:* _____
 Email:* _____
 Contact preference:* Phone Email

3- Shipping information

Ship to:* _____
 Name: _____
 Address: _____
 City: _____ State: _____
 Zip Code: _____
 Phone: _____

* Required		MA082 <input type="checkbox"/>	MA089 <input type="checkbox"/>	Taxes not included
		English Manual (STD)	Spanish Manual	USD
WC11	<input type="checkbox"/>	Ultralight Aluminum APEX Rigid Wheelchair (265 lb weight limit) Not available with painted frame - Frame will be black	Triple-butted aluminum frame / Aluminum back canes and back rigidizer / Aluminum seat rigidizer / Ultralight carbon fiber camber tube and rear frame rigidizer	K0005 \$2,595
WC21	<input type="checkbox"/>	Apex Carbon fiber frame upgrade (High Gloss Carbon Fiber)	Ultralight carbon fiber frame, back canes, back rigidizer, seat rigidizer, camber tube and rear frame rigidizer.	\$2,450
EVO-R	<input type="checkbox"/>	Evo Rigid - Chair resizing service*	To be used within 24 months of chair purchase	Aluminum \$750 Carbon \$1,000

*By selecting this option, I agree to the terms and conditions of the EVO-RIGID program. https://www.motioncomposites.com/en_us/terms-and-conditions

Frame										
SEAT WIDTH										
SW	<input type="checkbox"/>	12" <input type="checkbox"/>	13" <input type="checkbox"/>	14" <input type="checkbox"/>	15" <input type="checkbox"/>	16" <input type="checkbox"/>	17" <input type="checkbox"/>	18" <input type="checkbox"/>	19" <input type="checkbox"/>	NC
	<input type="checkbox"/>		20" <input type="checkbox"/>							E2201 \$505
SEAT DEPTH										
SD	<input type="checkbox"/>	12" <input type="checkbox"/>	13" <input type="checkbox"/>	14" <input type="checkbox"/>	15" <input type="checkbox"/>	16" <input type="checkbox"/>	17" <input type="checkbox"/>	18" <input type="checkbox"/>	19" <input type="checkbox"/>	NC
	<input type="checkbox"/>		20" <input type="checkbox"/>							E2203 \$485
FRAME LENGTH										
SP01	<input type="checkbox"/>	Standard frame length configuration ¹								STD
SP02	<input type="checkbox"/>	Frame length 1" longer than standard configuration								NC
SP03	<input type="checkbox"/>	Frame length 2" longer than standard configuration								NC
SP04	<input type="checkbox"/>	Frame length 1" shorter than standard configuration								NC
SP05	<input type="checkbox"/>	Frame length 2" shorter than standard configuration								NC
TIE-DOWN										
AC05-S	<input type="checkbox"/>	WC-19 Transit Tie Down w/Q'straint belt ^{2,3} Short belt 20"-41"								\$365
AC05-L	<input type="checkbox"/>	WC-19 Transit Tie Down w/Q'straint belt ^{2,3} Long belt 20"-46"								\$365
AC35	<input type="checkbox"/>	WC-19 Transit Tie Down without belt ³								\$335

1- Distance of 4.37" from end of seat upholstery to bend

2- Not available with depth adjustable back; 3- May interfere with the swing away armrest and the clamp on height adjustable push handle; Add a 3" of frame length behind backrest

4. [Width calculator](#)

FRONT Seat-to-floor height		
Caster sizes	Height available +- 1/4"	
<input type="checkbox"/> 3" Caster	14" to 21"	
<input type="checkbox"/> 4" Caster	14.5" to 21"	
<input type="checkbox"/> 5" Caster	15.5" to 21"	
<input type="checkbox"/> 6" Caster	16.5" to 21" (N/A with 90° front frame)	

Specify desired height:

_____ (inches)

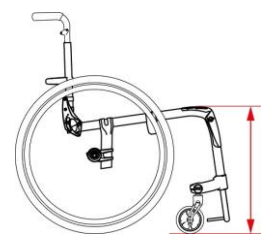

CASTERS				Available	
CA01-03 to CA01-06	<input type="checkbox"/>	Composite wheel w/ PU tire (1")		3", 4", 5", 6"	NC
CA10	<input type="checkbox"/>	Pneumatic casters (1 ¼")		6"	\$165
CA14 to CA16	<input type="checkbox"/>	Newton UltraCaster Composite (1 ½ ")		4", 5", 6"	\$95
CA17 to CA19	<input type="checkbox"/>	Newton UltraCaster Aluminum (1 ½ ")		4", 5", 6"	\$215
CASTER OPTIONS					
CA13	<input type="checkbox"/>	Carbon fiber Frog Legs suspension forks		E1015	\$490

REAR Seat-to-floor height		
Wheel sizes	Height available +- 1/4"	Specify desired height: _____ (inches)
<input type="checkbox"/> 20" (451) wheel	14" to 17.5"	
<input type="checkbox"/> 22" (501) wheel	14" to 18.5"	
<input type="checkbox"/> 24" (540) wheel	15" to 19.5"	
<input type="checkbox"/> 25" (559) wheel	15.5" to 20"	
<input type="checkbox"/> 26" (590) wheel	16" to 20"	

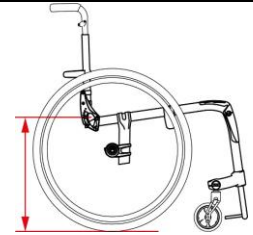

FRONT FRAME ANGLE					
FA70	<input type="checkbox"/>	70° Front frame angle			NC
FA75	<input type="checkbox"/>	75° Front frame angle			NC
FA80	<input type="checkbox"/>	80° Front frame angle			NC
FA85	<input type="checkbox"/>	85° Front frame angle			NC
FA90	<input type="checkbox"/>	90° Front frame angle			NC

Seat upholstery to footplate length	
12" to 19" without high mount	Specify desired length: _____ (inches) <i>Required</i>
7" to 13" with high mount ¹	

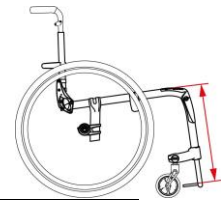

1- Choose high mount in the footplates section

Footrest width / Taper selection				
Seat Width	Straight	1" Taper	2" Taper	
Outside Measurement	2 ½" Narrower than Seat Width	4 ½" Narrower than Seat Width	6 ½" Narrower than Seat Width	
12"	9.5"	7.5"		
13"	10.5"	8.5"		
14"	11.5"	9.5"		
15"	12.5"	10.5"		
16"	13.5"	11.5"	9.5"	
17"	14.5"	12.5"	10.5"	
18"	15.5"	13.5"	11.5"	
19"	16.5"	14.5"	12.5"	
20"	17.5"	15.5"	13.5"	

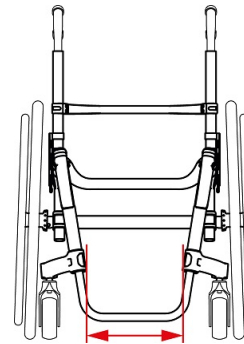

Note: higher than 20" Front STFH will reduce the footrest width up to 1" with a 2" taper

FOOTPLATES					
FP12	<input type="checkbox"/>	Tubular open loop ¹			STD
FP13	<input type="checkbox"/>	Tubular with ABS cover			NC
FP31	<input type="checkbox"/>	Newton adjustable angle - Aluminum (<i>one piece</i>)		K0040	\$97
FP32	<input type="checkbox"/>	Newton adjustable angle - Carbon fiber (<i>one piece with rubber inserts</i>)		K0040	\$190
FP14	<input type="checkbox"/>	Flip back, adjustable angle aluminum		K0040	\$200
FP15	<input type="checkbox"/>	Flip back, adjustable angle carbon fiber		K0040	\$295
FR25	<input type="checkbox"/>	High mount with adjustable angle footplate (<i>Aluminum - one piece</i>)		K0040	\$170
FR26	<input type="checkbox"/>	High mount with adjustable angle footplate (<i>Carbon fiber with rubber inserts - one piece</i>)		K0040	\$250

FOOTPLATES ACCESSORIES					
FP16	<input type="checkbox"/>	2" riser (<i>only available with aluminum angle adjustable footplate</i>) ²			\$77
FP09	<input type="checkbox"/>	Calf strap		K0038	\$36
FP30	<input type="checkbox"/>	Bodypoint Aeromesh Padded calf strap		K0038	\$118

1 - Available on: all straight frames; 1" taper with seat width of 14" and greater; 2" taper with seat width of 16" and greater

2- Not available with high mount

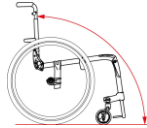
Backrest																																								
FOLD DOWN BACKREST																																								
BC20	<input type="checkbox"/>	Locking backrest			STD																																			
BC21	<input type="checkbox"/>	Ultralight non locking backrest (not locking in upright and down position) ²			\$102																																			
FIXED HEIGHT, ADJUSTABLE ANGLE FOLD DOWN BACKREST (Not available with push handles)																																								
BC	<input type="checkbox"/>	Fixed height without push handle	(30) 9" <input type="checkbox"/>	(31) 9.5" <input type="checkbox"/>	(32) 10" <input type="checkbox"/>	(33) 10.5" <input type="checkbox"/>	(34) 11" <input type="checkbox"/>	(35) 11.5" <input type="checkbox"/>	(36) 12" <input type="checkbox"/>	(37) 12.5" <input type="checkbox"/>	(38) 13" <input type="checkbox"/>	(39) 13.5" <input type="checkbox"/>	(40) 14" <input type="checkbox"/>	(41) 14.5" <input type="checkbox"/>	(42) 15" <input type="checkbox"/>	(43) 15.5" <input type="checkbox"/>	(44) 16" <input type="checkbox"/>	(45) 16.5" <input type="checkbox"/>	(46) 17" <input type="checkbox"/>	(47) 17.5" <input type="checkbox"/>	(48) 18" <input type="checkbox"/>	(49) 18.5" <input type="checkbox"/>	(50) 19" <input type="checkbox"/>	(51) 19.5" <input type="checkbox"/>	(52) 20" <input type="checkbox"/>	(53) 20.5" <input type="checkbox"/>	(54) 21" <input type="checkbox"/>	NC												
HEIGHT AND ANGLE ADJUSTABLE FOLD DOWN BACKREST WITH PUSH HANDLE OPTIONS (MUST select ONE push handle options)																																								
BC	<input type="checkbox"/>	Straight back canes	(22) 9 - 12" <input type="checkbox"/>	(23) 12 - 15" <input type="checkbox"/>	(24) 15 - 18" <input type="checkbox"/>	(25) 18 - 21" <input type="checkbox"/>																							NC											
Set height to: *		(in increments of 1/2", measured from seat sling to top of back upholstery) * If not indicated, default height setting is at the lowest position																																						
Select back cane angle: ¹		101° <input type="checkbox"/>	99° <input type="checkbox"/>	96° <input type="checkbox"/>	93° <input type="checkbox"/>	90° <input type="checkbox"/>	87° <input type="checkbox"/>	83° <input type="checkbox"/>	80° <input type="checkbox"/>																															STD

1 - If not indicated default angle setting is at 93°; 2- Maximum back cane height of 19.5" with aluminum chair

PUSH HANDLES OPTIONS (ONE option at a time)					
PH01	<input type="checkbox"/>	Push handles			STD
PH05	<input type="checkbox"/>	Fold down push handles			\$145
PH06-920	<input type="checkbox"/>	Clamp on height adjustable push handles 9 - 20" ¹			\$325
PH06-923	<input type="checkbox"/>	Clamp on height adjustable push handles 9 - 23" ¹			\$325
PH02	<input type="checkbox"/>	Omit push handles			NC
STROLLER HANDLE					
PH04	<input type="checkbox"/>	Stroller handle (Push handles included)		K0108	\$165

1 - Not compatible with swing away armrests;

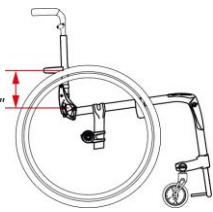
BACKRESTS OPTIONS					
BC61	<input type="checkbox"/>	Depth adjustable back - 1" depth adjustment ^{1,4}			\$195
BC62	<input type="checkbox"/>	Depth adjustable back - 2" depth adjustment ^{2,4}			\$195
BC56	<input type="checkbox"/>	Depth adjustable back - 3" depth adjustment ^{3,4}			\$195
BC57	<input type="checkbox"/>	Standard 3 inch deep rigidizer bar			STD
BC55	<input type="checkbox"/>	Four inch deep Aluminum rigidizer bar			NC
BC88	<input type="checkbox"/>	Custom height rigidizer bar set at _____ (inches)			\$135
		Measured from the top of the seat sling to the center of the rigidizer - standard height is 5,7" Lowest position is 4,25"			

If used in combination with WC-19: 1- Maximum depth of 19"; 2- Maximum depth of 18"; 3- Maximum depth of 17"; 4- Only compatible with WC-19 transit tie down **without** Q-Strait belt

BACK UPHOLSTERY					
BH03	<input type="checkbox"/>	Slip-on Syntech-Suede back upholstery			STD
BH04	<input type="checkbox"/>	Adjustable tension Syntech-Suede back upholstery		E2611	\$305
BH99	<input type="checkbox"/>	Omit Back upholstery			NC
	<input type="checkbox"/>	NXT back Support		See price list	
SEAT CUSHION					
SC01	<input type="checkbox"/>	2" Cushion			\$170
SC02	<input type="checkbox"/>	3" Cushion		E2601/E2602	\$190
SC99	<input type="checkbox"/>	Omit seat cushion			STD
	<input type="checkbox"/>	NXT cushion		See price list	

Rear wheels						
REAR WHEELS					Available	
RW01	<input type="checkbox"/>	Mag ¹			20", 22" 24"	\$57
RW02	<input type="checkbox"/>	Newton One - spoke wheel ²			20", 22" 24"	STD
RW03	<input type="checkbox"/>	Newton Gravity - ultralight wheel			20", 22", 24", 25", 26"	\$360
RW04	<input type="checkbox"/>	Spinergy Spox	Blk STD <input type="checkbox"/>	Wht ³ <input type="checkbox"/> Blue ³ <input type="checkbox"/> Red ³ <input type="checkbox"/> Yel ³ <input type="checkbox"/>	22", 24", 25", 26"	\$915
RW05	<input type="checkbox"/>	Spinergy LX	Blk STD <input type="checkbox"/>	Pur ³ <input type="checkbox"/> Wht ³ <input type="checkbox"/> Blue ³ <input type="checkbox"/> Red ³ <input type="checkbox"/> Yel ³ <input type="checkbox"/> Pink ³ <input type="checkbox"/> Grn ³ <input type="checkbox"/> Org ³ <input type="checkbox"/>	22", 24", 25", 26"	\$1,145
RW07	<input type="checkbox"/>	Spinergy CLX ⁴	Blk STD <input type="checkbox"/>	Pur ³ <input type="checkbox"/> Wht ³ <input type="checkbox"/> Blue ³ <input type="checkbox"/> Red ³ <input type="checkbox"/> Yel ³ <input type="checkbox"/> Pink ³ <input type="checkbox"/> Grn ³ <input type="checkbox"/> Org ³ <input type="checkbox"/>	24", 25"	\$1,625
TIRES					Available	
AIRLESS						
TI01	<input type="checkbox"/>	Soft Urethane 1 3/8" - Low Tread, black			20", 22" 24"	E2218 NC
TI02	<input type="checkbox"/>	Soft Urethane 1 3/8" - Medium Tread, black ⁵			22", 24", 25", 26"	E2218 \$97
TI04	<input type="checkbox"/>	Soft Urethane 1" - No tread, black - <i>Shox</i>			22", 24", 25", 26"	E2218 \$118
TI08	<input type="checkbox"/>	Pneumatic Airless insert 1 3/8" - Medium Tread ⁶			22", 24", 26"	E2211/E2213 \$82
PNEUMATIC						
TI05	<input type="checkbox"/>	Pneumatic 1 3/8" - Medium Tread			20", 22", 24", 25", 26"	E2211/E2212 STD
TI06	<input type="checkbox"/>	Pneumatic HP 1" - Low Tread, Puncture resistant, black - <i>SpeedLite</i>			20", 22", 24", 25", 26"	E2211/E2212 \$105
TI07	<input type="checkbox"/>	Pneumatic HP 1" - Medium Tread, Puncture resistant, black - <i>TrailBlazer</i>			24", 25", 26"	E2211/E2212 \$150
TI03	<input type="checkbox"/>	Pneumatic 2" - Large Tread, black ⁷			22", 24", 25"	E2211/E2212 \$115

1- Not compatible with HP tires; Only available with aluminum or plastic coated handrim in standard position; 2- Not compatible with Shox tires; 3- Colour spokes require an additional 10 days lead-time;
4- Only available with 1" tires; 5- The 22" is only available with Mags and Newton One rear wheels; 6- Not available with Spinergy CLX, Spinergy LX 25", 26" and Spox 25", 26" rear wheels
7- Not available when armrests and 4", 6", 8" camber are selected.

Handrims						
HANDRIM					Available	
HR01	<input type="checkbox"/>	Aluminum anodized			20", 22", 24", 25", 26"	STD
HR61	<input type="checkbox"/>	Aluminum black hard anodized ²			20", 22", 24", 25"	\$75
HR02	<input type="checkbox"/>	Plastic coated ¹			20", 22", 24", 25", 26"	\$110
HR03	<input type="checkbox"/>	High friction coated ^{1,2}			22", 24", 25", 26"	\$375
HR07-HR18 and HR65-HR71	<input type="checkbox"/>	Newton Air Grip ²	<i>See page 6 for the color selection and price</i>		20", 22", 24", 25", 26"	
HR28	<input type="checkbox"/>	Surge ^{1,2} (1 1/2" Oval handrim w/ Gripton high friction strip)			22", 24", 25", 26"	\$450
HR05	<input type="checkbox"/>	Surge LT ^{1,2} (1 1/8" Oval handrim w/ Gripton high friction strip)			22", 24", 25", 26"	\$495
HR04	<input type="checkbox"/>	Natural Fit ^{1,2}			22", 24", 25", 26"	\$395
HR62	<input type="checkbox"/>	Simi H ^{1,2} (1 3/8" Oval handrim with high friction strip)			22", 24", 25", 26"	\$395
HR63	<input type="checkbox"/>	Nova H ^{1,2} (1 1/4" Oval handrim with high friction strip)			22", 24", 25", 26"	\$445
HR64	<input type="checkbox"/>	Optimum H ^{1,2} (1 1/8" heart-shaped handrim)			22", 24", 25", 26"	\$345
HR99	<input type="checkbox"/>	Omit handrim				NC

1- Only standard and narrow handrim position. By default, the tab won't be cut with the narrow position; 2- Not available with Mag wheels

Handrims option					
ASSEMBLY POSITION					
HR29	<input type="checkbox"/>	Standard Handrim position	<i>Full tab</i>		STD
HR030	<input type="checkbox"/>	Narrow Handrim position no cut	<i>Full tab</i>		NC
HR30	<input type="checkbox"/>	Narrow Handrim position with cut ³	<i>Short tab 2 positions</i>		\$30
HR31	<input type="checkbox"/>	Super Narrow Handrim ³	<i>Short tab 2 positions STD <input type="checkbox"/> Short tab 1 position <input type="checkbox"/></i>		\$30
THUMB PIECE SELECTION FOR NATURAL FIT, SURGE, SURGE LT HANDRIMS					
HR23	<input type="checkbox"/>	Standard grip			\$95
HR27	<input type="checkbox"/>	Super grip			\$150
HR099	<input type="checkbox"/>	Omit thumb piece			NC

3- Only available with Aluminum and Air Grip handrims;

AXLES					
AX01	<input type="checkbox"/>	Quick release axle			STD
AX03	<input type="checkbox"/>	Quad release axle		K0108	\$130

REAR WHEEL CAMBER					
CM00	<input type="checkbox"/>	0° camber			STD
CM02	<input type="checkbox"/>	2° camber			NC
CM04	<input type="checkbox"/>	4° camber			NC
CM06	<input type="checkbox"/>	6° camber			NC
CM08	<input type="checkbox"/>	8° camber			NC

CENTER OF GRAVITY	
Specify the position of rear wheel axle plate:	
Measure distance from front of back post to center of axle receiver.	
0 - 6" range	Set At: _____ (inches)
<i>If not indicated, default setting is at 2.5"</i>	
<i>Motion Composites will select the closest possible center of gravity (COG) if an issue arises with the COG</i>	

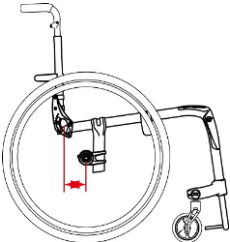

WHEEL LOCK					
WL08	<input type="checkbox"/>	Newton wheel lock - push to lock			STD
WL16	<input type="checkbox"/>	Aluminum push to lock with extensions		E0961	\$77
WL02	<input type="checkbox"/>	Pull to lock			NC
WL04	<input type="checkbox"/>	Newton grade aid push to lock <i>(works best with pneumatic or high pressure tire)</i>		E0974	\$155
WL13 WL14	<input type="checkbox"/>	6" removable extension handle ¹		E0961	\$77
WL05	<input type="checkbox"/>	Scissors lock			\$155
WL99	<input type="checkbox"/>	Omit wheel locks			NC

1- Only available with Newton push to lock (WL08), pull to lock (WL02) and Newton Grade aid (WL04)

		Armrests			
HEIGHT ADJUSTABLE "T" ARMREST ¹					
AR13-610	<input type="checkbox"/>	10" Desk length armpad ²	6" - 10"		\$330
AR03-812	<input type="checkbox"/>	10" Desk length armpad	8" - 12"		\$330
AR03-1014	<input type="checkbox"/>	10" Desk length armpad	10" - 14"		\$330
AR14-610	<input type="checkbox"/>	14" Full length armpad ³	6" - 10"		\$330
AR04-812	<input type="checkbox"/>	14" Full length armpad	8" - 12"		\$330
AR04-1014	<input type="checkbox"/>	14" Full length armpad	10" - 14"		\$330
HEIGHT ADJUSTABLE SWING AWAY ARMREST ²					
AR05	<input type="checkbox"/>	Tubular armrest without plastic side guards - Short pad	8" - 11"	E0973	\$230
AR19	<input type="checkbox"/>	Tubular armrest with plastic side guards - short pad	8" - 11"	E0973	\$395
AR23	<input type="checkbox"/>	Tubular armrest without plastic side guards - long pad	8" - 11"	E0973	\$230
AR24	<input type="checkbox"/>	Tubular armrest with plastic side guards - long pad	8" - 11"	E0973	\$395
AR06	<input type="checkbox"/>	10" Desk length flat armpad without plastic side guards	8" - 11"	E0973	\$230
AR20	<input type="checkbox"/>	10" Desk length flat armpad with plastic side guards	8" - 11"	E0973	\$395
AR17	<input type="checkbox"/>	14" Full length flat armpad without plastic side guards	8" - 11"	E0973	\$230
AR21	<input type="checkbox"/>	14" Full length flat armpad with plastic side guards	8" - 11"	E0973	\$395
ARMREST OPTIONS					
AR12	<input type="checkbox"/>	14" Full Length armpad - Gel Ovation (pair) ⁴			\$165
AR99	<input type="checkbox"/>	Omit armrest			NC

1- May have 1/2" adjustment restriction on both limits of the range; 2- not available with the Ultralight non-locking backrest; 3- May have some restriction with seat-to-floor height and rear wheel

4- Only available with "T" full length armrest; Not available with swing away and desk length armrests

SIDE GUARDS (not available with "T" Armrest)						
SG01	<input type="checkbox"/>	Plastic side guards (removable)	Straight bracket - STD	Offset bracket ¹	PRODUCT IMPROVED	K0108 \$200
SG03	<input type="checkbox"/>	Carbon fiber side guards (removable)	Straight bracket - STD	Offset bracket ¹	PRODUCT IMPROVED	K0108 \$305
SG06	<input type="checkbox"/>	Plastic fender side guards (removable)	Straight bracket - STD	Offset bracket ¹		\$290
SG04	<input type="checkbox"/>	Carbon fiber fender side guards (removable)	Straight bracket - STD	Offset bracket ¹	PRODUCT IMPROVED	K0108 \$550
SG99	<input type="checkbox"/>	Omit side guards				NC
SIDE GUARDS OPTION						
SG07	<input type="checkbox"/>	Side guard clip (pair)				NC

1- only compatible with 0° and 2° camber; increase width by 1/2" per side for a total of 1"

POSITIONING BELT					
SB01-S	<input type="checkbox"/>	Velcro adjustable - Small 35" ¹		E0978	\$46
SB01-L	<input type="checkbox"/>	Velcro adjustable - Long 60"		E0978	\$46
SB02-S	<input type="checkbox"/>	Auto buckle - Small 35" ¹		E0978	\$87
SB02-M	<input type="checkbox"/>	Auto buckle - Medium 48"		E0978	\$87
SB02-L	<input type="checkbox"/>	Auto buckle - Long 60"		E0978	\$87
SB04-M	<input type="checkbox"/>	BodyPoint Hip Belt - 2 point not padded - Medium 56"		E0978	\$85
SB04-L	<input type="checkbox"/>	BodyPoint Hip Belt - 2 point not padded - Long 61"		E0978	\$85
SB05-S	<input type="checkbox"/>	BodyPoint Hip Belt - 2 point padded - Small 51"		E0978	\$180
SB05-M	<input type="checkbox"/>	BodyPoint Hip Belt - 2 point padded - Medium 56"		E0978	\$180
SB05-L	<input type="checkbox"/>	BodyPoint Hip Belt - 2 point padded - Long 61"		E0978	\$180
SB06-S	<input type="checkbox"/>	BodyPoint Hip Belt - 4 point padded - Small 51"		E0978	\$195
SB06-M	<input type="checkbox"/>	BodyPoint Hip Belt - 4 point padded - Medium 56"		E0978	\$195
SB06-L	<input type="checkbox"/>	BodyPoint Hip Belt - 4 point padded - Long 61"		E0978	\$195
SB03	<input type="checkbox"/>	Hardware attachment for 2 extra points (1 pair)			\$17
SB08-M	<input type="checkbox"/>	BodyPoint EVOFLEX® Positioning Belt Rehab latch and Band Clamps - Medium 18"		K0108	\$305
SB08-L	<input type="checkbox"/>	BodyPoint EVOFLEX® Positioning Belt Rehab latch and Band Clamps - Long 24"		K0108	\$305
SB99	<input type="checkbox"/>	Omit positioning belt			STD

1- Not recommended for seat width of 18" and more

ACCESSORIES									
AC03	<input type="checkbox"/>	Anti-tippers						E0971	\$145
AC06	<input type="checkbox"/>	Cane and crutch holder	Left <input type="checkbox"/>	Right <input type="checkbox"/>				E2207	\$200
AC08	<input type="checkbox"/>	Spoke guards ¹	Available: 20", 22", 24", 26"					K0065	\$118
AC10	<input type="checkbox"/>	Seat pouch							\$82
AC30	<input type="checkbox"/>	Newton multi-purpose pouch							\$61
AC26	<input type="checkbox"/>	BodyPoint Mobility Bag							\$135
AC23	<input type="checkbox"/>	Newton Backpack							\$130
AC13	<input type="checkbox"/>	Tool kit							\$51
AC16	<input type="checkbox"/>	Motion Composites Polo Shirt	W/S <input type="checkbox"/>	W/M <input type="checkbox"/>	W/L <input type="checkbox"/>				\$36
			M/S <input type="checkbox"/>	M/M <input type="checkbox"/>	M/L <input type="checkbox"/>	M/XL <input type="checkbox"/>	M/XXL <input type="checkbox"/>	M/XXXL <input type="checkbox"/>	
AC15	<input type="checkbox"/>	Military Patches	Army <input type="checkbox"/>	Navy <input type="checkbox"/>	Air Force <input type="checkbox"/>	Marines <input type="checkbox"/>	Coast Guard <input type="checkbox"/>		\$97
			Combat Wounded Purple Heart <input type="checkbox"/>	Space Force <input type="checkbox"/>	American Flag <input type="checkbox"/>				

1- Not available with Mag wheels and Spinerig

Colors																					
Options ¹	Black	High Gloss Carbon Fiber	Sunkissed Orange	Burgundy	Sapphire Blue	Monster Green	Charcoal	Fuchsia	Steel Blue	Ferrari Red	Acid Green	Electric Purple	Caribbean Blue	White	Pink Pearl	Plum Purple	Sky Blue	Black Cherry	Khaki Green (matte)	Desert Sand (matte)	
AirGrip	<input type="checkbox"/> \$110		<input type="checkbox"/>	<input type="checkbox"/>	<input type="checkbox"/>	<input type="checkbox"/>	<input type="checkbox"/>	<input type="checkbox"/>	<input type="checkbox"/>	<input type="checkbox"/>	<input type="checkbox"/>	<input type="checkbox"/>	<input type="checkbox"/>	<input type="checkbox"/>	<input type="checkbox"/>	<input type="checkbox"/>	<input type="checkbox"/>	<input type="checkbox"/>	<input type="checkbox"/>	<input type="checkbox"/>	\$265
Carbon Fiber Frame		<input type="checkbox"/> STD	<input type="checkbox"/>	<input type="checkbox"/>	<input type="checkbox"/>	<input type="checkbox"/>	<input type="checkbox"/>	<input type="checkbox"/>	<input type="checkbox"/>	<input type="checkbox"/>	<input type="checkbox"/>	<input type="checkbox"/>	<input type="checkbox"/>	<input type="checkbox"/>	<input type="checkbox"/>	<input type="checkbox"/>	<input type="checkbox"/>	<input type="checkbox"/>	<input type="checkbox"/>	<input type="checkbox"/>	NC
Camber Tube	<input type="checkbox"/> STD/NC		<input type="checkbox"/>	<input type="checkbox"/>	<input type="checkbox"/>	<input type="checkbox"/>	<input type="checkbox"/>	<input type="checkbox"/>	<input type="checkbox"/>	<input type="checkbox"/>	<input type="checkbox"/>	<input type="checkbox"/>	<input type="checkbox"/>	<input type="checkbox"/>	<input type="checkbox"/>	<input type="checkbox"/>	<input type="checkbox"/>	<input type="checkbox"/>	<input type="checkbox"/>	<input type="checkbox"/>	\$60
Highlight ³	<input type="checkbox"/>		<input type="checkbox"/>					<input type="checkbox"/>		<input type="checkbox"/>	<input type="checkbox"/>			<input type="checkbox"/>			<input type="checkbox"/>				NC
FC99 ²	<input type="checkbox"/>	Custom Color	Specify PPG Paintit color:																	<i>additional 10 days lead-time</i>	\$390

1- Color representation may vary from one monitor to another. Therefore, the actual paint color on your wheelchair might differ slightly from what you see on your screen.; Finish between Airgrip and frame might be different;

2- Only available with carbon fiber upgrade; 3- To see different highlight, visit our website:

https://www.motioncomposites.com/en_us/products/rigid-wheelchairs/apex-c

Notes :

 <p>NXCABF _____ (W" x D")</p> <p>HPCPS CODE: E2607-E2608</p>	WIDTH									
	DEPTH	12"	13"	14"	15"	16"	17"	18"	19"	20"
		12"	\$445	\$445	\$445					
		14"	\$445	\$445	\$445					
		15"		\$445	\$445	\$445	\$445			
		16"		\$445	\$445	\$445	\$445	\$445	\$480	\$480
		17"				\$445	\$445	\$445	\$445	\$480
		18"				\$445	\$445	\$445	\$445	\$480
		19"				\$445	\$445	\$445	\$445	\$480
		20"				\$445	\$445	\$445	\$480	\$480
Option: Change cover for incontinent/infection control outer cover										\$N/C

SEATING AND CUSHION ACCESSORIES

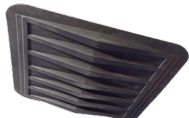
	MODEL NO.	Description	Fits Back Width	\$	QTY
	RSSI 1600	Solid Seat Insert	Fits cushions 16" & 17" wide (40.6 & 43.2 cm) and 14"-18" deep (35.6-45.7 cm)	80	
	RSSI 1600	Solid Seat Insert	Fits cushions 18" & 19" wide (45.7 & 48.3 cm) and 14"-18" deep (35.6-45.7 cm)	80	
	RSSI 1600	Solid Seat Insert	Fits cushions 20"-22" wide (50.8-55.9 cm) and 18"-20" deep (45.7-50.8 cm)	80	

THORACIC SHAPE	 <p>Optima™ THORACIC BACK SUPPORT</p> <p>CARBON FIBER SHELL (WEIGHT SAVINGS - 1lb) HPCPS CODE: E2620-E2621</p>	Fits Width	Height	Model # CARBON FIBER	\$ CARBON	Model # Aluminum	\$ Aluminum
		13"-15"	7"			NOACB1307	\$695
		13"-15"	9"			NOACB1309	\$695
		13"-15"	13"			NOACB1313	\$695
		13"-15"	16"			NOACB1316	\$695
		14"-16"	7"			NOACB1407	\$695
		14"-16"	9"	NOCFACB1409	\$895	NOACB1409	\$695
		14"-16"	13"	NOCFACB1413	\$925	NOACB1413	\$695
		14"-16"	16"	NOCFACB1416	\$960	NOACB1416	\$695
		15"-17"	7"			NOACB1507	\$695
		15"-17"	9"	NOCFACB1509	\$895	NOACB1509	\$695
		15"-17"	13"	NOCFACB1513	\$925	NOACB1513	\$695
		15"-17"	16"	NOCFACB1516	\$960	NOACB1516	\$695
		16"-18"	7"			NOACB1607	\$695
		16"-18"	9"	NOCFACB1609	\$895	NOACB1609	\$695
		16"-18"	13"	NOCFACB1613	\$925	NOACB1613	\$695
		16"-18"	16"	NOCFACB1616	\$960	NOACB1616	\$695
		17"-19"	7"			NOACB1707	\$695
		17"-19"	9"	NOCFACB1709	\$895	NOACB1709	\$695
		17"-19"	13"	NOCFACB1713	\$925	NOACB1713	\$695
		17"-19"	16"	NOCFACB1716	\$960	NOACB1716	\$695
		18"-20"	7"			NOACB1807	\$695
18"-20"	9"	NOCFACB1809	\$895	NOACB1809	\$695		
18"-20"	13"	NOCFACB1813	\$925	NOACB1813	\$695		
18"-20"	16"	NOCFACB1816	\$960	NOACB1816	\$695		
20"-22"	7"			NOACB2007	\$695		
20"-22"	9"	NOCFACB2009	\$895	NOACB2009	\$695		
20"-22"	13"	NOCFACB2013	\$925	NOACB2013	\$695		
20"-22"	16"	NOCFACB2016	\$960	NOACB2016	\$695		

 <p>Optima™ DEEP THORACIC BACK SUPPORT</p> <p>CARBON FIBER SHELL (WEIGHT SAVINGS - 1lb) HPCPS CODE: E2620-E2621</p>	Fits Width	Height	Model # CARBON FIBER	\$ CARBON	Model # Aluminum	\$ Aluminum
	13"-15"	7"			NOPCB1307	\$695
	13"-15"	9"			NOPCB1309	\$695
	13"-15"	13"			NOPCB1313	\$695
	13"-15"	16"			NOPCB1316	\$695
	14"-16"	7"			NOPCB1407	\$695
	14"-16"	9"	NOCFPCB1409	\$995	NOPCB1409	\$695
	14"-16"	13"	NOCFPCB1413	\$1015	NOPCB1413	\$695
	14"-16"	16"	NOCFPCB1416	\$1055	NOPCB1416	\$695
	15"-17"	7"			NOPCB1507	\$695
	15"-17"	9"	NOCFPCB1509	\$995	NOPCB1509	\$695
	15"-17"	13"	NOCFPCB1513	\$1015	NOPCB1513	\$695
	15"-17"	16"	NOCFPCB1516	\$1055	NOPCB1516	\$695
	16"-18"	7"			NOPCB1607	\$695
	16"-18"	9"	NOCFPCB1609	\$995	NOPCB1609	\$695
	16"-18"	13"	NOCFPCB1613	\$1015	NOPCB1613	\$695
	16"-18"	16"	NOCFPCB1616	\$1055	NOPCB1616	\$695
	17"-19"	7"			NOPCB1707	\$695
	17"-19"	9"	NOCFPCB1709	\$995	NOPCB1709	\$695
	17"-19"	13"	NOCFPCB1713	\$1015	NOPCB1713	\$695
	17"-19"	16"	NOCFPCB1716	\$1055	NOPCB1716	\$695
	18"-20"	7"			NOPCB1807	\$695
18"-20"	9"	NOCFPCB1809	\$995	NOPCB1809	\$695	
18"-20"	13"	NOCFPCB1813	\$1015	NOPCB1813	\$695	
18"-20"	16"	NOCFPCB1816	\$1055	NOPCB1816	\$695	
20"-22"	7"			NOPCB2007	\$695	
20"-22"	9"	NOCFPCB2009	\$995	NOPCB2009	\$695	
20"-22"	13"	NOCFPCB2013	\$1015	NOPCB2013	\$695	
20"-22"	16"	NOCFPCB2016	\$1055	NOPCB2016	\$695	

ALL PRICES QUOTED IN USD. PRICES ARE SUBJECT TO CHANGE WITHOUT NOTICE.

For additional NXT models, sizes and hardware not shown, please refer to the complete NXT Seating Order Form at www.motioncomposites.com

BACK SUPPORT HARDWARE OPTIONS

All backs come STANDARD with QuickRelease Mounting Hardware. The following are fixed hardware options available at no charge when ordered with a back support.

Model #	DESCRIPTION	WEIGHT OF HARDWARE ONLY	✓
	QuickFit Quick Release Hardware System	STANDARD (2 LBS)	STANDARD
NIB-1642	Micro Mount 2 point fixed hardware. Back width needs to match chair width	Weight savings of 1.4 lb over STANDARD	
NIB-1207	2 point fixed hardware. Width expandable to fit 3 sizes of chair	Weight savings of 1.0 lb over STANDARD	

BACK SUPPORT ACCESSORIES – PRIVACY FLAP

Model #	Description	Fits Back Width	\$	QTY
NIB-1938	Extra Small Privacy Flap for 11" - 13" wide back supports	11" - 13" (27.9 - 33.0)	70	
NIB-1078	Small Privacy Flap for 14"-16" wide back supports	14" - 16" (35.6-40.6 cm)	100	
NIB-1079	Medium Flap for 17"-19" wide back supports	17" - 19" (43.2-48.3 cm)	100	
NIB-1080	Large Privacy Flap for 20"-22" wide back supports	20" - 22" (50.8-55.9 cm)	100	
NIB-1081	Extra Large Privacy Flap for 23" - 26" wide back supports	23" - 26" (58.4 - 66.0 cm)	100	

EXTRA COVERS

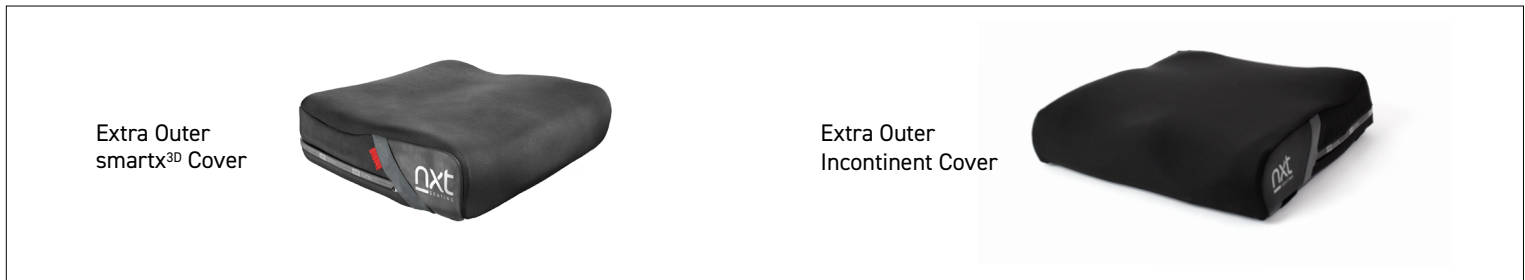

ITEM	WIDTH X DEPTH	\$	QTY
Extra Outer smartx ^{3D} Cover – For a cover up to 18" x 18"	__ __ X __ __	130	
Extra Outer smartx ^{3D} Cover – For a cover 18" x 20" and above	__ __ X __ __	150	
Extra Outer Incontinent Cover – For a cover up to 18" x 18"	__ __ X __ __	130	
Extra Outer Incontinent Cover – For a cover 18" x 20" and above	__ __ X __ __	150	

ALL PRICES QUOTED IN USD. PRICES ARE SUBJECT TO CHANGE WITHOUT NOTICE.

For additional NXT models, sizes and hardware not shown, please refer to the complete NXT Seating Order Form at www.motioncomposites.com