



**1- Purchasing information**

P.O. number:\* \_\_\_\_\_ Date: \_\_\_\_\_  
 Company Name:\* \_\_\_\_\_  
 Purchasing contact:\* \_\_\_\_\_  
 Phone:\* \_\_\_\_\_  
 Email:\* \_\_\_\_\_  
 Contact preference:\* Phone  Email   
 Marked for: \_\_\_\_\_

**3- Shipping information**

Ship to:\* \_\_\_\_\_  
 Name: \_\_\_\_\_  
 Address: \_\_\_\_\_  
 City: \_\_\_\_\_ State: \_\_\_\_\_  
 Zip Code: \_\_\_\_\_  
 Phone: \_\_\_\_\_

**2- Clinician information**

Clinician:\* \_\_\_\_\_  
 Phone:\* \_\_\_\_\_  
 Email:\* \_\_\_\_\_  
 Contact preference:\* Phone  Email

\*Required MA043  English Manual (STD) MA044  German Manual MA045  Italian Manual MA046  Dutch Manual MA047  Spanish Manual MA048  French Manual MA090  Portuguese Manual taxes not included

MODEL							USD
WC11	<input type="checkbox"/>	Ultralight Aluminum APEX Rigid Wheelchair (120kg /265 lb weight limit) Not available with painted frame - Frame will be black	Triple-buttet aluminum frame / Aluminum back canes and back rigidizer / Aluminum seat rigidizer / Ultralight carbon fiber camber tube and rear frame rigidizer				\$2,795
WC21	<input type="checkbox"/>	Apex Carbon fiber frame upgrade (High Gloss Carbon Fiber)	Ultralight carbon fiber frame, back canes, back rigidizer, seat rigidizer, camber tube and rear frame rigidizer.				\$1,995
EVO-R	<input type="checkbox"/>	Evo Rigid - Chair resizing service*	To be used within 24 months of chair purchase				Aluminum \$750 Carbon \$1,000

\*By selecting this option, I agree to the terms and conditions of the EVO-RIGID program. [https://www.motioncomposites.com/en\\_us/terms-and-conditions](https://www.motioncomposites.com/en_us/terms-and-conditions)

**Frame**

SEAT WIDTH									
SW	<input type="checkbox"/>	30.48 (12")	<input type="checkbox"/> 33.02 (13")	<input type="checkbox"/> 35.56 (14")	<input type="checkbox"/> 38.10(15")	<input type="checkbox"/> 40.64(16")	<input type="checkbox"/> 43.18 (17")	<input type="checkbox"/> 45.72 (18")	NC
	<input type="checkbox"/>	48.26 (19")	<input type="checkbox"/> 50.80 (20")						

SEAT DEPTH									
SD	<input type="checkbox"/>	30.48 (12")	<input type="checkbox"/> 33.02 (13")	<input type="checkbox"/> 35.56 (14")	<input type="checkbox"/> 38.10(15")	<input type="checkbox"/> 40.64(16")	<input type="checkbox"/> 43.18 (17")	<input type="checkbox"/> 45.72 (18")	NC
	<input type="checkbox"/>	48.26 (19")	<input type="checkbox"/> 50.80 (20")						

FRAME LENGTH								
SP01	<input type="checkbox"/>	Standard frame length configuration <sup>1</sup>						STD
SP02	<input type="checkbox"/>	Frame length 2.54cm (1") longer than standard configuration						NC
SP03	<input type="checkbox"/>	Frame length 5.08cm (2") longer than standard configuration						NC
SP04	<input type="checkbox"/>	Frame length 2.54cm (1") shorter than standard configuration						NC
SP05	<input type="checkbox"/>	Frame length 5.08cm (2") shorter than standard configuration						NC

TIE-DOWN							
AC05-S	<input type="checkbox"/>	WC-19 Transit Tie Down w/Q'straint belt <sup>2,3</sup>	Short belt 50-104 (20-41")				\$365
AC05-L	<input type="checkbox"/>	WC-19 Transit Tie Down w/Q'straint belt <sup>2,3</sup>	Long belt 50-116 (20-46")				\$365
AC35	<input type="checkbox"/>	WC-19 Transit Tie Down without belt <sup>3</sup>					\$335

1- Distance of 4.37" from end of seat upholstery to bend  
 2- Not available with depth adjustable back; 3- May interfere with the swing away armrest and the clamp on height adjustable push handle; Add a 3" of frame length behind backrest

**FRONT Seat-to-floor height**

Caster sizes	Height available +/- 1/4"	Specify desired height:  _____ (inches)
<input type="checkbox"/> 3" Caster	35.6cm to 53.3cm (14" to 21")	
<input type="checkbox"/> 4" Caster	36.8cm to 53.3cm (14.5" to 21")	
<input type="checkbox"/> 5" Caster	39.4cm to 53.3cm (15.5" to 21")	
<input type="checkbox"/> 6" Caster	41.9cm to 53.3cm (16.5" to 21") (N/A with 90° front frame)	



CASTERS				Availability	
CA01-03 to CA01-06	<input type="checkbox"/>	Composite wheel w/ PU tire (1")		3", 4", 5", 6"	NC
CA10	<input type="checkbox"/>	Pneumatic casters (1 ¼")		6"	\$175
CA14 to CA16	<input type="checkbox"/>	Newton UltraCaster Composite (1 ½")		4", 5", 6"	\$98
CA17 to CA19	<input type="checkbox"/>	Newton UltraCaster Aluminum (1 ½")		4", 5", 6"	\$198
CASTER OPTIONS					
CA13	<input type="checkbox"/>	Carbon fiber Frog Legs suspension forks			\$515

REAR Seat-to-floor height		
Wheel sizes	Height available +/- 1/4"	
20" (451) wheel	35.5cm to 44.5cm (14" to 17.5")	
22" (501) wheel	35.5cm to 47cm (14" to 18.5")	
24" (540) wheel	38.1cm to 49.5cm (15" to 19.5")	
25" (559) wheel	39.4cm to 50.8cm (15.5" to 20")	
26" (590) wheel	40.6cm to 50.8cm (16" to 20")	

Specify desired height:

\_\_\_\_\_ (inches)

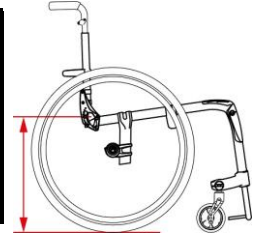

FRONT FRAME ANGLE					
FA70	<input type="checkbox"/>	70° Front frame angle			NC
FA75	<input type="checkbox"/>	75° Front frame angle			NC
FA80	<input type="checkbox"/>	80° Front frame angle			NC
FA85	<input type="checkbox"/>	85° Front frame angle			NC
FA90	<input type="checkbox"/>	90° Front frame angle			NC

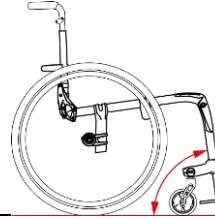

Seat upholstery to footplate length		
30.48 to 48.26cm (12" to 19") without high mount		Specify desired length: _____ (inches) <i>Required</i>
17.78 to 33.02cm (7" to 13") with high mount <sup>1</sup>		



1- Choose high mount in the footplates section

Seat Width		Footrest width / Taper selection		
		Straight	2,5 cm (1") Taper	5cm (2") Taper
Outside Measurement (cm)		6.4cm (2 1/2") Narrower than Seat Width	11.4cm (4 1/2") Narrower than Seat Width	16.6 cm (6 1/2") Narrower than Seat Width
30.5	12"	24.1 9.5"	19.1 7.5"	
33.0	13"	26.7 10.5"	21.6 8.5"	
35.6	14"	29.2 11.5"	24.1 9.5"	
38.1	15"	31.8 12.5"	26.7 10.5"	
40.6	16"	34.3 13.5"	29.2 11.5"	24.1 9.5"
43.2	17"	36.8 14.5"	31.8 12.5"	26.7 10.5"
45.7	18"	39.4 15.5"	34.3 13.5"	29.2 11.5"
48.3	19"	41.9 16.5"	36.8 14.5"	31.8 12.5"
50.8	20"	44.5 17.5"	39.4 15.5"	34.3 13.5"

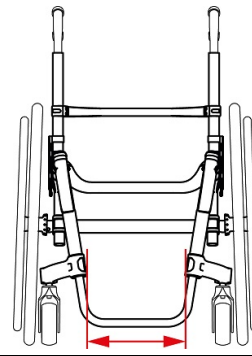

Note: higher than 50.8cm (20"), front STFH will reduce the footrest width up to 2,5cm (1") with a 5cm (2") taper

FOOTPLATES			
FP12	<input type="checkbox"/>	Tubular open loop <sup>1</sup>	STD
FP13	<input type="checkbox"/>	Tubular with ABS cover	NC
FP31	<input type="checkbox"/>	Adjustable angle - Aluminum (one piece)	\$105
FP32	<input type="checkbox"/>	Newton adjustable angle - Carbon fiber (one piece with rubber inserts)	\$190
FP14	<input type="checkbox"/>	Flip back, adjustable angle aluminum	\$210
FP15	<input type="checkbox"/>	Flip back, adjustable angle carbon fiber	\$300
FR25	<input type="checkbox"/>	High mount with adjustable angle footplate (Aluminum - one piece)	\$180
FR26	<input type="checkbox"/>	High mount with adjustable angle footplate (Carbon fiber with rubber inserts - one piece)	\$250

FOOTPLATES ACCESSORIES			
FP16	<input type="checkbox"/>	5.08cm (2") riser (only available with aluminum angle adjustable footplate) <sup>2</sup>	\$78
FP09	<input type="checkbox"/>	Calf strap	\$40
FP30	<input type="checkbox"/>	Bodypoint Aeromesh Padded calf strap	\$125

1 - Available on: all straight frames; 2,5cm (1") taper with seat width of 14" and greater; 5cm (2") taper with seat width of 16" and greater; 2- Not available with high mount

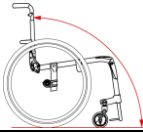
Backrest				
<b>FOLD DOWN BACKREST</b>				
BC20	<input type="checkbox"/>	Locking backrest		STD
BC21	<input type="checkbox"/>	Ultralight non locking backrest (not locking in upright and down position) <sup>2</sup>		\$105
<b>FIXED HEIGHT, ADJUSTABLE ANGLE FOLD DOWN BACKREST (Not available with push handles)</b>				
BC	<input type="checkbox"/>	<b>Fixed height without push handle</b>	(30) 22.8cm/9" <input type="checkbox"/> (31) 24.1cm/9.5" <input type="checkbox"/> (32) 25.4cm/10" <input type="checkbox"/> (33) 26.7cm/10.5" <input type="checkbox"/> (34) 27.9cm/11" <input type="checkbox"/>	NC
		(35) 29.2cm/11.5" <input type="checkbox"/> (36) 30.5cm/12" <input type="checkbox"/> (37) 31.7cm/12.5" <input type="checkbox"/> (38) 33cm/13" <input type="checkbox"/> (39) 34.3cm/13.5" <input type="checkbox"/> (40) 35.5cm/14" <input type="checkbox"/> (41) 35.8cm/14.5" <input type="checkbox"/>		
		(42) 38.1cm/15" <input type="checkbox"/> (43) 39.4cm/15.5" <input type="checkbox"/> (44) 40.6cm/16" <input type="checkbox"/> (45) 41.9cm/16.5" <input type="checkbox"/> (46) 43.2cm/17" <input type="checkbox"/> (47) 44.5cm/17.5" <input type="checkbox"/> (48) 45.7cm/18" <input type="checkbox"/>		
		(49) 47cm/18.5" <input type="checkbox"/> (50) 48.3/19" <input type="checkbox"/> (51) 49.5cm/19.5" <input type="checkbox"/> (52) 50.8cm/20" <input type="checkbox"/> (53) 52.7cm/20.5" <input type="checkbox"/> (54) 53.3cm/21" <input type="checkbox"/>		
<b>HEIGHT AND ANGLE ADJUSTABLE FOLD DOWN BACKREST WITH PUSH HANDLE OPTIONS (MUST select ONE push handle options)</b>				
BC	<input type="checkbox"/>	<b>Straight back canes</b>	(22) 22.8 - 30.5cm <input type="checkbox"/> (23) 30.5 - 38.1cm <input type="checkbox"/> (24) 38.1 - 45.7cm <input type="checkbox"/> (25) 45.7 - 53.3cm <input type="checkbox"/>	NC
<b>Set height to: *</b>		(in increments of 1/2", measured from seat sling to top of back upholstery) * If not indicated, default height setting is at the lowest position		
Select back cane angle: <sup>1</sup>		101° <input type="checkbox"/> 99° <input type="checkbox"/> 96° <input type="checkbox"/> <b>93°</b> <input type="checkbox"/> 90° <input type="checkbox"/> 87° <input type="checkbox"/> 83° <input type="checkbox"/> 80° <input type="checkbox"/>		STD

<sup>1</sup> - If not indicated default angle setting is at 93°; <sup>2</sup> - Maximum back cane height of 19.5" with the aluminum chair

<b>PUSH HANDLES OPTIONS (ONE option at a time)</b>				
PH01	<input type="checkbox"/>	Push handles		STD
PH05	<input type="checkbox"/>	Fold down push handles		\$140
PH06-920	<input type="checkbox"/>	Clamp on height adjustable push handles 22.9-50.80cm (9 - 20") <sup>1</sup>		\$330
PH06-923	<input type="checkbox"/>	Clamp on height adjustable push handles 22.9-58.4cm (9 - 23") <sup>1</sup>		\$330
PH02	<input type="checkbox"/>	Omit push handles		NC

<sup>1</sup> - Not compatible with swing away armrests;

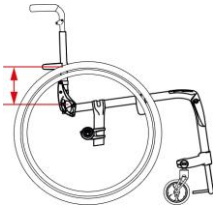
<b>BACKRESTS OPTIONS</b>				
BC61	<input type="checkbox"/>	Depth adjustable back - 2.54cm (1") depth adjustment <sup>1,4</sup>		\$195
BC62	<input type="checkbox"/>	Depth adjustable back - 5.08cm (2") depth adjustment <sup>2,4</sup>		\$195
BC56	<input type="checkbox"/>	Depth adjustable back - 7.62cm (3") depth adjustment <sup>3,4</sup>		\$195
BC57	<input type="checkbox"/>	Standard 7.62cm (3") deep rigidizer bar		STD
BC55	<input type="checkbox"/>	Four inch deep Aluminum rigidizer bar		NC
BC88	<input type="checkbox"/>	<b>Custom height rigidizer bar set at</b>  _____ (inches)  Measured from the top of the seat sling to the center of the rigidizer - standard height is 5,7" Lowest position is 4,25"		\$135

If used in combination with WC-19: **1** - Maximum depth of 19"; **2** - Maximum depth of 18"; **3** - Maximum depth of 17"; **4** - Only compatible with WC-19 transit tie down **without** Q'Straint belt

<b>BACK UPHOLSTERY</b>				
BH03	<input type="checkbox"/>	Slip-on Syntech-Suede back upholstery		STD
BH04	<input type="checkbox"/>	Adjustable tension Syntech-Suede back upholstery		\$180
BH99	<input type="checkbox"/>	Omit Back upholstery		NC
<b>SEAT CUSHION</b>				
SC01	<input type="checkbox"/>	5.08cm (2") Cushion		\$180
SC02	<input type="checkbox"/>	7.62cm (3") Cushion		\$200
SC99	<input type="checkbox"/>	Omit seat cushion		STD

## Rear wheels

REAR WHEELS					Available	
RW01	<input type="checkbox"/>	Mag <sup>1</sup>			20", 22" 24"	\$57
RW02	<input type="checkbox"/>	Newton One - spoke wheel <sup>2</sup>			20", 22" 24"	STD
RW03	<input type="checkbox"/>	Newton Gravity - ultralight wheel			20", 22", 24", 25", 26"	\$335
RW04	<input type="checkbox"/>	Spinergy Spox	Blk STD <input type="checkbox"/>	Wht <sup>3</sup> <input type="checkbox"/> Blue <sup>3</sup> <input type="checkbox"/> Red <sup>3</sup> <input type="checkbox"/> Yel <sup>3</sup> <input type="checkbox"/>	22", 24", 25", 26"	\$865
RW05	<input type="checkbox"/>	Spinergy LX	Blk STD <input type="checkbox"/> Pur <sup>3</sup> <input type="checkbox"/>	Wht <sup>3</sup> <input type="checkbox"/> Blue <sup>3</sup> <input type="checkbox"/> Red <sup>3</sup> <input type="checkbox"/> Yel <sup>3</sup> <input type="checkbox"/> Pink <sup>3</sup> <input type="checkbox"/> Grn <sup>3</sup> <input type="checkbox"/> Org <sup>3</sup> <input type="checkbox"/>	22", 24", 25", 26"	\$1,095
RW07	<input type="checkbox"/>	Spinergy CLX <sup>4</sup>	Blk STD <input type="checkbox"/> Pur <sup>3</sup> <input type="checkbox"/>	Wht <sup>3</sup> <input type="checkbox"/> Blue <sup>3</sup> <input type="checkbox"/> Red <sup>3</sup> <input type="checkbox"/> Yel <sup>3</sup> <input type="checkbox"/> Pink <sup>3</sup> <input type="checkbox"/> Grn <sup>3</sup> <input type="checkbox"/> Org <sup>3</sup> <input type="checkbox"/>	24", 25"	\$1,600
TIRES					Available	
Solid						
TI01	<input type="checkbox"/>	Soft Urethane 3.49cm (1 3/8")			20", 22" 24"	NC
TI02	<input type="checkbox"/>	Soft Urethane knobby 3.49cm (1 3/8 ") <sup>5</sup>			22", 24", 25", 26"	\$105
TI04	<input type="checkbox"/>	Soft Urethane 2.54cm (1") - Shox			22", 24", 25", 26"	\$125
Pneumatic						
TI05	<input type="checkbox"/>	Pneumatic 3.49cm (1 3/8")			20", 22", 24", 25", 26"	STD
TI08	<input type="checkbox"/>	Pneumatic with Airless insert 3.49cm (1 3/8") <sup>6</sup>			22", 24", 26"	\$90
TI06	<input type="checkbox"/>	Pneumatic HP, Low Tread, Puncture resistant, black 2.54cm (1") - SpeedLite			20", 22", 24", 25", 26"	\$110
TI07	<input type="checkbox"/>	Pneumatic HP, Medium Tread, Puncture resistant, black 2.54cm (1") - TrailBlazer			24", 25", 26"	\$140

1- Not compatible with HP tires; Only available with aluminum or plastic coated handrim in standard position; 2- Not compatible with Shox tires; 3- Colour spokes require an additional 10 days lead-time; 4- Only available with 1" tires; 5- The 22" is only available with Mags and Newton One rear wheels; 6- Not available with Spinergy CLX, Spinergy LX 25", 26" and Spox 25", 26" rear wheels

## Handrims

HANDRIM					Available	
HR01	<input type="checkbox"/>	Aluminum anodized			20", 22", 24", 25", 26"	STD
HR61	<input type="checkbox"/>	Aluminum black hard anodized <sup>2</sup>			20", 22", 24", 25"	\$75
HR02	<input type="checkbox"/>	Plastic coated <sup>1</sup>			20", 22", 24", 25", 26"	\$110
HR03	<input type="checkbox"/>	High friction coated <sup>1,2</sup>			22", 24", 25", 26"	\$380
HR07-HR18 and HR65-HR71	<input type="checkbox"/>	Newton Air Grip <sup>2</sup>	<i>See page 6 for the color selection and price</i>		20", 22", 24", 25", 26"	
HR28	<input type="checkbox"/>	Surge <sup>1,2</sup> (1 1/2" Oval handrim w/ Gripton high friction strip)			22", 24", 25", 26"	\$425
HR05	<input type="checkbox"/>	Surge LT <sup>1,2</sup> (1 1/8" Oval handrim w/ Gripton high friction strip)			22", 24", 25", 26"	\$465
HR04	<input type="checkbox"/>	Natural Fit <sup>1,2</sup>			22", 24", 25", 26"	\$335
HR62	<input type="checkbox"/>	Simi H <sup>1,2</sup> (1 1/4" Oval handrim with high friction strip)			22", 24", 25", 26"	\$395
HR63	<input type="checkbox"/>	Nova H <sup>1,2</sup> (1 1/4" Oval handrim with high friction strip)			22", 24", 25", 26"	\$425
HR64	<input type="checkbox"/>	Optimum H <sup>1,2</sup> (1 1/8" heart-shaped handrim)			22", 24", 25", 26"	\$325
HR99	<input type="checkbox"/>	Omit handrim				NC

1- Only standard and narrow handrim position. By default, the tab won't be cut with the narrow position; 2- Not available with Mag wheels

## Handrims option

ASSEMBLY POSITION						
HR29	<input type="checkbox"/>	Standard Handrim position	Full tab			STD
HR030	<input type="checkbox"/>	Narrow Handrim position no cut	Full tab			NC
HR30	<input type="checkbox"/>	Narrow Handrim position with cut <sup>3</sup>	Short tab 2 positions			\$32
HR31	<input type="checkbox"/>	Super Narrow Handrim <sup>3</sup>	Short tab 2 positions STD <input type="checkbox"/>	Short tab 1 position <input type="checkbox"/>		\$32
THUMB PIECE SELECTION FOR NATURAL FIT, SURGE, SURGE LT HANDRIMS						
HR23	<input type="checkbox"/>	Standard grip				\$95
HR27	<input type="checkbox"/>	Super grip				\$150
HR099	<input type="checkbox"/>	Omit thumb piece				NC

3- Only available with Aluminum and Air Grip handrims;

AXLES						
AX01	<input type="checkbox"/>	Quick release axle				STD
AX03	<input type="checkbox"/>	Quad release axle				\$135
REAR WHEEL CAMBER						
CM00	<input type="checkbox"/>	0° camber				STD
CM02	<input type="checkbox"/>	2° camber				NC
CM04	<input type="checkbox"/>	4° camber				NC
CM06	<input type="checkbox"/>	6° camber				NC
CM08	<input type="checkbox"/>	8° camber				NC

CENTER OF GRAVITY	
Specify the position of rear wheel axle plate:	
Measure distance from front of back post to center of axle receiver.	
0 - 6" range	Set At: _____ (inches)
If not indicated, default setting is at 2.5"	
Motion Composites will select the closest possible center of gravity (COG) if an issue arises with the COG	

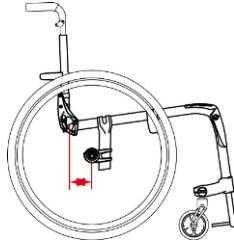

WHEEL LOCK				
WL08	<input type="checkbox"/>	Newton wheel lock - push to lock		STD
WL14	<input type="checkbox"/>	6" removable extension handle for push to lock		\$83
WL16	<input type="checkbox"/>	Aluminum push to lock with extensions		\$83
WL02	<input type="checkbox"/>	Pull to lock		NC
WL04	<input type="checkbox"/>	Newton grade aid push to lock ( <i>works best with pneumatic or high pressure tire</i> )		\$165
WL13	<input type="checkbox"/>	6" removable extension handle for pull to lock and grade aid		\$83
WL05	<input type="checkbox"/>	Scissors lock		\$155
WL99	<input type="checkbox"/>	Omit wheel locks		NC

### Armrests

HEIGHT ADJUSTABLE "T" ARMREST <sup>1</sup>				
AR13-610	<input type="checkbox"/>	25.4cm (10") Desk Length armpad <sup>3</sup>	15.25 - 25cm (6" - 10")	\$350
AR03-812	<input type="checkbox"/>	25.4cm (10") Desk Length armpad	20.32 - 30.48cm (8" - 12")	\$350
AR03-1014	<input type="checkbox"/>	25.4cm (10") Desk Length armpad	25.40 - 35.56cm (10" - 14")	\$350
AR14-610	<input type="checkbox"/>	35.56cm (14") Full Length armpad <sup>3</sup>	15.25 - 25cm (6" - 10")	\$350
AR04-812	<input type="checkbox"/>	35.56cm (14") Full Length armpad	20.32 - 30.48cm (8" - 12")	\$350
AR04-1014	<input type="checkbox"/>	35.56cm (14") Full Length armpad	25.40 - 35.56cm (10" - 14")	\$350

HEIGHT ADJUSTABLE SWING AWAY ARMREST <sup>2</sup>				
AR05	<input type="checkbox"/>	Tubular armrest - Short pad		\$240
AR23	<input type="checkbox"/>	Tubular armrest - Long pad		\$240
AR06	<input type="checkbox"/>	25.4cm (10") Desk Length flat armpad	20.32 - 27.94cm (8 - 11")	\$240
AR17	<input type="checkbox"/>	35.56cm (14") Full Length flat armpad	20.32 - 27.94cm (8 - 11")	\$240
AR99	<input type="checkbox"/>	Omit armrest		NC

1- May have 1/2" adjustment restriction on both limits of the range; 2- not available with the Ultralight non-locking backrest; 3- May have some restriction with seat-to-floor height and rear wheel

SIDE GUARDS (not available with "T" Armrest)				
SG01	<input type="checkbox"/>	Plastic side guards ( <i>removable</i> )		\$210
SG03	<input type="checkbox"/>	Carbon fiber side guards ( <i>removable</i> )		\$315
SG06	<input type="checkbox"/>	Plastic fender side guards - straight bracket ( <i>removable</i> )		\$295
SG08	<input type="checkbox"/>	Plastic fender side guards - offset bracket ( <i>removable</i> ) <sup>1</sup>		\$295
SG04	<input type="checkbox"/>	Carbon fiber fender side guards ( <i>removable</i> )		\$550
SG99	<input type="checkbox"/>	Omit side guards		NC

SIDE GUARDS OPTION				
SG07	<input type="checkbox"/>	Side guard clip ( <i>pair</i> )		NC

1- only compatible with 0° and 2° camber; Increase distance between fender side guards by 1 1/8"











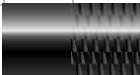





























POSITIONING BELT				
SB01-S	<input type="checkbox"/>	Velcro adjustable - <b>Standard 88.9cm (35")</b> <sup>1</sup>		\$50
SB01-L	<input type="checkbox"/>	Velcro adjustable - <b>Long 152.40cm (60")</b>		\$50
SB02-S	<input type="checkbox"/>	Auto buckle - <b>Standard 88.9cm (35")</b> <sup>1</sup>		\$95
SB02-L	<input type="checkbox"/>	Auto buckle - <b>Long 152.40cm (60")</b>		\$95
SB04-M	<input type="checkbox"/>	BodyPoint Hip Belt - 2 point not padded - <b>Medium 142.24cm (56")</b>		\$95
SB04-L	<input type="checkbox"/>	BodyPoint Hip Belt - 2 point not padded - <b>Long 154.94cm (61")</b>		\$95
SB05-S	<input type="checkbox"/>	BodyPoint Hip Belt - 2 point padded - <b>Small 129.54cm (51")</b>		\$185
SB05-M	<input type="checkbox"/>	BodyPoint Hip Belt - 2 point padded - <b>Medium 142.24cm (56")</b>		\$185
SB05-L	<input type="checkbox"/>	BodyPoint Hip Belt - 2 point padded - <b>Long 154.94cm (61")</b>		\$185
SB06-S	<input type="checkbox"/>	BodyPoint Hip Belt - 4 point padded - <b>Small 129.54cm (51")</b>		\$205
SB06-M	<input type="checkbox"/>	BodyPoint Hip Belt - 4 point padded - <b>Medium 142.24cm (56")</b>		\$205
SB06-L	<input type="checkbox"/>	BodyPoint Hip Belt - 4 point padded - <b>Long 154.94cm (61")</b>		\$205
SB03	<input type="checkbox"/>	Hardware attachment for 2 extra points (1 pair)		\$17
SB08-M	<input type="checkbox"/>	BodyPoint EVOFLEX® Positioning Belt Rehab latch and Band Clamps - <b>Medium 73.66cm (18")</b>		\$310
SB08-L	<input type="checkbox"/>	BodyPoint EVOFLEX® Positioning Belt Rehab latch and Band Clamps - <b>Long 93.98cm (24")</b>		\$310
SB99	<input type="checkbox"/>	Omit positioning belt		STD

1- Not available with wheelchair width of 45.72cm (18") and more

ACCESSORIES				
AC03	<input type="checkbox"/>	Anti-tippers		\$150
AC06	<input type="checkbox"/>	Cane and crutch holder	Left <input type="checkbox"/> Right <input type="checkbox"/>	\$130
AC08	<input type="checkbox"/>	Spoke guards <sup>1</sup>	Available: 20", 22", 24", 26"	\$125
AC10	<input type="checkbox"/>	Seat pouch		\$83
AC30	<input type="checkbox"/>	Newton multi-purpose pouch		\$62
AC26	<input type="checkbox"/>	BodyPoint Mobility Bag		\$135
AC23	<input type="checkbox"/>	Newton Backpack		\$130
AC13	<input type="checkbox"/>	Tool kit		\$50
AC16	<input type="checkbox"/>	Motion Composites Polo Shirt	W/S <input type="checkbox"/> W/M <input type="checkbox"/> W/L <input type="checkbox"/> M/S <input type="checkbox"/> M/M <input type="checkbox"/> M/L <input type="checkbox"/> M/XL <input type="checkbox"/> M/XXL <input type="checkbox"/> M/XXXL <input type="checkbox"/>	\$36

1- Not available with Mag wheels and Spinerig

Colors

Options <sup>1</sup>	Black	High Gloss Carbon Fiber	Sunkissed Orange	Burgundy	Sapphire Blue	Monster Green	Charcoal	Fuchsia	Steel Blue	Ferrari Red	Acid Green	Electric Purple	Caribbean Blue	White	Pink Pearl	Plum Purple	Sky Blue	Black Cherry	Khaki Green (matte)	Desert Sand (matte)		
																						
AirGrip	<input type="checkbox"/> \$110		<input type="checkbox"/>	<input type="checkbox"/>	<input type="checkbox"/>	<input type="checkbox"/>	<input type="checkbox"/>	<input type="checkbox"/>	<input type="checkbox"/>	<input type="checkbox"/>	<input type="checkbox"/>	<input type="checkbox"/>	<input type="checkbox"/>	<input type="checkbox"/>	<input type="checkbox"/>	<input type="checkbox"/>	<input type="checkbox"/>	<input type="checkbox"/>	<input type="checkbox"/>	<input type="checkbox"/>	<input type="checkbox"/>	\$265
Carbon Fiber Frame		<input type="checkbox"/> STD	<input type="checkbox"/>	<input type="checkbox"/>	<input type="checkbox"/>	<input type="checkbox"/>	<input type="checkbox"/>	<input type="checkbox"/>	<input type="checkbox"/>	<input type="checkbox"/>	<input type="checkbox"/>	<input type="checkbox"/>	<input type="checkbox"/>	<input type="checkbox"/>	<input type="checkbox"/>	<input type="checkbox"/>	<input type="checkbox"/>	<input type="checkbox"/>	<input type="checkbox"/>	<input type="checkbox"/>	<input type="checkbox"/>	NC
Camber Tube	<input type="checkbox"/> STD/NC		<input type="checkbox"/>	<input type="checkbox"/>	<input type="checkbox"/>	<input type="checkbox"/>	<input type="checkbox"/>	<input type="checkbox"/>	<input type="checkbox"/>	<input type="checkbox"/>	<input type="checkbox"/>	<input type="checkbox"/>	<input type="checkbox"/>	<input type="checkbox"/>	<input type="checkbox"/>	<input type="checkbox"/>	<input type="checkbox"/>	<input type="checkbox"/>	<input type="checkbox"/>	<input type="checkbox"/>	<input type="checkbox"/>	\$60
																						
Highlight <sup>3</sup>	<input type="checkbox"/>		<input type="checkbox"/>					<input type="checkbox"/>		<input type="checkbox"/>				<input type="checkbox"/>			<input type="checkbox"/>					NC
FC99 <sup>2</sup>	<input type="checkbox"/>	Custom Color	<a href="#">Specify PPG Paintit color:</a>																	<i>additional 10 days lead-time</i>	\$390	

1- Color representation may vary from one monitor to another. Therefore, the actual paint color on your wheelchair might differ slightly from what you see on your screen.; Finish between Airgrip and frame might be different;  
 2- Only available with carbon fiber upgrade; 3- To see different highlight, visit our website:

[https://www.motioncomposites.com/en\\_intl/products/riqid-wheelchairs/apex-c](https://www.motioncomposites.com/en_intl/products/riqid-wheelchairs/apex-c)

Notes :